

DOCUMENT RESUME

ED 091 216

SE 017 789

TITLE Skylab Experiments, Volume 5, Astronomy and Space Physics.

INSTITUTION National Aeronautics and Space Administration, Washington, D.C.

REPORT NO EP-114

PUB DATE May 73

NOTE 86p.; For related documents, see SE 016 464 and 465, SE 016 991, SE 017 106, SE 017 788, and SE 017 790

AVAILABLE FROM Superintendent of Documents, Government Printing Office, Washington, D.C. 20402

EDRS PRICE MF-\$0.75 HC-\$4.20 PLUS POSTAGE.

DESCRIPTORS *Aerospace Technology; *Astronomy; *Instructional Materials; Pollution; Radiation; *Science Activities; Science Education; *Science Materials; Secondary School Science; Space Sciences

IDENTIFIERS NASA; *Skylab Education Program

ABSTRACT

Basic knowledge about Skylab experiments is presented in this book, one of a series, for the purpose of informing high school teachers about scientific research performed in orbit and enabling the teachers to broaden their basis for material selection. This fifth volume is concerned with studies of our own and other galaxies and effects of solar radiation on Earth's atmosphere. The topics include the solar system, cosmic ray studies, stellar astronomy, spacecraft in space environment, radiation in spacecraft, ultraviolet airglow horizon photography, gegenschein/zodiacal light, particle collection, lunar libration clouds, objects within Mercury's orbit, x-rays from Jupiter, magnetospheric particle composition, cosmic ray nuclear emulsion, transuranic cosmic rays, neutron analysis, ultraviolet stellar astronomy and panorama, galactic x-ray mapping, spectrography of selected quasars, pulsars in the ultraviolet wavelengths, x-ray content in association with stellar, spectral classes, and contamination measurements. Experiment background, scientific objectives, relationships between the Skylab investigations and high school topics, and suggestions for classroom activities are provided. Included is a glossary of terms. (CC)

EP-114

U.S. DEPARTMENT OF HEALTH
EDUCATION & WELFARE
NATIONAL INSTITUTE OF
EDUCATION

THIS DOCUMENT HAS BEEN REPRODUCED AS IS, WITHOUT EDITING, BY THE NATIONAL INSTITUTE OF EDUCATION. POINTS OF VIEW OR OPINIONS STATED DO NOT NECESSARILY REPRESENT THE NATIONAL INSTITUTE OF EDUCATION.

ED 091216

Skylab Experiments

Volume 5 Astronomy and Space Physics

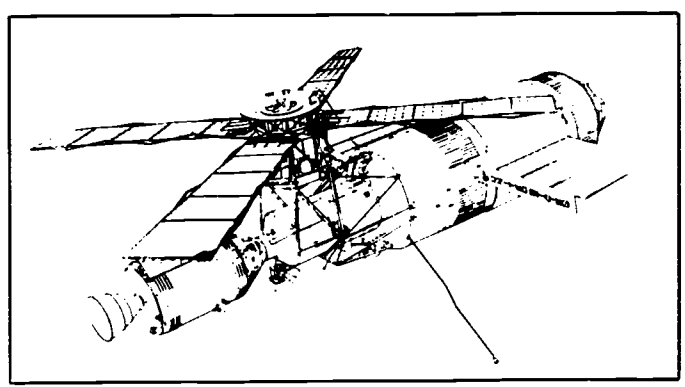

Information for Teachers, Including Suggestions
on Relevance to School Curricula.

NATIONAL AERONAUTICS AND SPACE ADMINISTRATION

SEA17 789



Skylab Experiments

Volume 5 Astronomy and Space Physics

Produced by the Skylab Program and NASA's Education Programs
Division in Cooperation with the University of Colorado

NATIONAL AERONAUTICS AND SPACE ADMINISTRATION
Washington, D.C. 20546, May 1973

PREFACE

Characteristically, new scientific knowledge reaches general application in classrooms years after it has been obtained. This long delay stems, to a large extent, from a lack of awareness that information is available and that it has relevance to secondary school curricula. To accelerate this process, the National Aeronautics and Space Administration has prepared a series of documents concerning Skylab experiments to apprise the educational community in detail of the investigations being conducted in the Skylab Program, and the types of information being produced.

The objective is not to introduce the Skylab Program as a subject in the classroom, but rather to make certain that the educational community is aware of the information being generated and that will be available for use. Readers are urged to use these books as an aid in planning development of future curriculum supplement material to make the most appropriate use of this source of scientific knowledge.

National Aeronautics and Space Administration
Washington, D. C. 20546
May 1973

CONTENTS

SECTION 1—INTRODUCTION

The Solar System	1
Cosmic Ray Studies	2
Stellar Astronomy	3
Spacecraft in Space Environment	6
Radiation in Spacecraft	6

SECTION 2—SOLAR SYSTEM PHENOMENA

Ultraviolet Airglow Horizon Photography	9
Gegenschein/Zodiacal Light	13
Particle Collection	15
Lunar Libration Clouds	21
Objects within Mercury's Orbit	22
X-rays from Jupiter	23

SECTION 3—THE ENERGETIC PARTICLE REFINEMENT

Magnetospheric Particle Composition	25
Cosmic Ray Nuclear Emulsion	27
Transuranic Cosmic Rays	31
Neutron Analysis	33

SECTION 4—STELLAR AND GALACTIC ASTRONOMY

Ultraviolet Stellar Astronomy	37
Ultraviolet Panorama	41
Galactic X-ray Mapping	47
Spectrography of Selected Quasars	50
A Search for Pulsars in the Ultraviolet Wavelengths	50
X-ray Content in Association with Stellar Spectral Classes	51

SECTION 5—SPACECRAFT ENVIRONMENT

Contamination Measurement	53
Coronagraph Contamination Measurement	60
Radiation in Spacecraft	62

SECTION 6—GLOSSARY 71

INTRODUCTION

The Skylab Education Program

This year the United States' first manned scientific space station, Skylab, was launched into orbit to be the facility in which successive crews of astronauts can perform more than 270 scientific investigations in a variety of fields of interest. These investigations can be divided into four categories: physical sciences, biomedical sciences, earth applications, and space applications.

The Skylab Program will produce information that will enhance present scientific knowledge and perhaps extend the frontiers of knowledge on subjects ranging from the nature of the universe to the structure of the single human cell. It is the objective of the National Aeronautics and Space Administration that the knowledge derived from the Skylab Program's investigations be made available to the educational community for applications to high school education at the earliest possible date.

For this reason, the Skylab Education Program was created to assure that maximum educational benefits are obtained from the Skylab effort, documentation of Skylab activities is adequately conducted, and understanding of scientific developments is enhanced.

This document, one of several volumes prepared as part of the Skylab Education Program, has the dual purpose of (1) informing high school teachers about the scientific investigations performed in Skylab, and (2) enabling teachers to evaluate the educational benefits the Skylab Program can provide.

These books will define the objectives of each experiment, describe the scientific background on which the experiment is based, outline the experimental procedures, and indicate the types of data anticipated.

In preparing these documents an attempt has been made to illustrate relationships between the planned Skylab investigations and high school science topics. Concepts for classroom activities have been included that use specific elements of Skylab science as focal points for demonstrations of selected subjects. In some areas these address current curriculum topics by providing practical applications of relatively familiar, but sometimes abstract principles; in other areas the goal is to provide an introduction to phenomena rarely addressed in high school science curricula.

It is the hope of the National Aeronautics and Space Administration that these volumes will assist the high school teacher in recognizing the educational value of the information resulting from the Skylab Program which is available to all who desire to make use of it.

Application

Readers are asked to evaluate the investigations described herein in terms of the scientific subjects taught in secondary schools. The related curriculum topics identified should serve as suggestions for the application of Skylab Program-generated information to classroom activities. As information becomes available from the Skylab Program, announcements will be distributed to members of the educational community on the NASA Educational

Programs Division mailing list. To obtain these announcements send name, title, and full school mailing list (including zip code) to:

National Aeronautics and Space Administration
Washington, D.C. 20546
Mail Code FE

This volume deals with the study of certain aspects of space physics as addressed in the Skylab Program. The subjects discussed range from the effects of solar radiation on Earth's atmosphere through solar system phenomena to the study of our own and other galaxies.

By providing background information in each field, Section 1 of this volume serves as a unifying introduction to the investigations discussed.

Sections 2 through 5 discuss the investigations in detail, and Section 6 consists of a glossary of terms.

Wherever possible, relationships have been developed between the Skylab scientific investigations and classroom science curricula. These are discussed Sections 2 through 5 and are summarized in Table 1.

Acknowledgments

Valuable guidance was provided in the area of relevance to high school curricula by Dr. James R. Wailes, Professor of Science Education, School of Education, University of Colorado; assisted by Mr. Kenneth C. Jacknicke, Research Associate on leave from the University of Alberta, Edmonton, Alberta, Canada; Mr. Russel Yeany, Jr., Research Associate, on leave from the Armstrong School District, Pennsylvania; and Dr. Harry Herzer and Mr. Duane Houston, Education and Research Foundation, Oklahoma State University.

The Skylab Program

The Skylab orbiting space station will serve as a workshop and living quarters for astronauts as they perform investigations in the following broad categories: physical sciences, biomedical sciences, Earth applications, and space applications.

The spacecraft will remain operational for an eight-month period, manned on three occasions and unmanned during intervening periods of operation. Each manned flight will have a crew of three different astronauts. The three flights are planned for durations of one month, two months, and two months, respectively.

A summary of objectives of each of the categories of investigation follows.

Physical Science

Observations free of filtering and obscuring effects of the Earth's atmosphere will be performed to increase man's knowledge of (1) the sun and of its importance to Earth and

Table 1 Related Curriculum Topics

EXPERIMENTS	SUBJECT	ASTRONOMY	BIOLOGY	CHEMISTRY	ELECTRONICS	PHOTOGRAPHY	PHYSICS
SECTION 1 BACKGROUND		Stellar classes, novae, quasars and the red shift, pulsars, cosmic rays, aurora, zodiacal light, gegenschein, micrometeorites, radiation from Jupiter, radiation belts, Skylab's atmosphere density	Health hazard of x-rays, cosmic rays, and solar particles	Z-number, ozone production			Secondary radiation, magnetic field effects on cosmic rays
SECTION 2 SOLAR SYSTEM PHENOMENA		Micrometeorites, meteoritic dust reflection, asteroids, zodiacal light, gegenschein, F-corona, airglow, twilight airglow, red arcs, noctilucent clouds		Chemical examination, of micrometeorites; ozone production, photochemistry of Earth's upper atmosphere	Micrometeorite detector, pressure cells, microphones, capacitors	35mm camera characteristics photodensitometry, photometric scanning	Reflection by dust particles, libration points, x-rays
SECTION 3 ENERGETIC PARTICLE ENVIRONMENT		Cosmic rays, Z-number, supernovae, magnetosphere, solar wind, solar and galactic cosmic rays		Column density, nuclei classification, chemical etching, inert gases, mass spectrometer analysis		Photographic emulsion, developing and fixing, nuclear emulsion	Creation of cosmic rays, secondary radiations, ionization, kinetic energy, radioactivity, electron volt energy spectrum, mass spectrometer principles, nuclear fusion, delectrics
SECTION 4 STELLAR ASTRONOMY		Stellar evolution, Hertzsprung-Russell diagram, broadband photometry, x-ray sources, stellar x-ray intensity vs solar, quasars, pulsars, eclipsing binaries, Cepheids		Absorption of ultraviolet radiation in atmosphere, spectrographic analysis	Proportional counter tubes, diodes, anodes, cathode, pulse height analyzer, star trackers	Spectral photometry, spectrographic camera	Hyperbolic mirrors, ultraviolet radiation, refraction index, dispersion spectra, diffraction creating, "insect eye" lens, Fabry image, spherical or cylindrical lenses, x-rays
SECTION 5 SPACECRAFT ENVIRONMENTS		Eclipses, F-corona, Van Allen radiation belt, cosmic rays, South Atlantic anomaly	Health hazard of x-rays, cosmic rays, secondary radiations; physiological variations in radiation absorption	Photo polymerization action and product analysis, thermoluminescent crystals, plastic polymer etching	Quartz crystal microbalance, photo multiplier tube, radiation dosimeter, tissue equivalent ionization chamber, linear energy transfer spectrometer, quartz fiber ionization chamber	Optical contamination and photography of scattered light, camera and filters; nuclear emulsions	Induced atmosphere density, sticking coefficient, thermal contamination efficiency, Rayleigh and Mie scattering theories, high energy shielding and absorption

mankind, and (2) the radiation and particulate environment in near-Earth space and the sources from which these phenomena emanate.

Biomedical Science

Observations under conditions different from those on Earth will be made to increase man's knowledge of the biological functions of living organisms, and of the capabilities of man to live and work for prolonged periods in the orbital environment.

Earth Applications

Techniques will be developed for observing from space and interpreting (1) Earth phenomena in the areas of agriculture, forestry, geology, geography, air and water pollution, land use and meteorology, and (2) the influence of man on these elements.

Space Applications

Techniques for adapting to and using the unique properties of space flight will be developed.

The Skylab Spacecraft

The Skylab cluster contains five modules (see illustration).

1) The *orbital workshop* is the prime living and working area for the Skylab crews. It contains living and sleeping quarters, food preparation and eating areas, and personal hygiene equipment. It also contains the equipment for the biomedical science experiments and for some of the physical science and space applications experiments. Solar arrays for generation of electrical power are mounted outside this module.

2) The *airlock module* contains the airlock through which suited astronauts emerge to perform activities outside the cluster. It also contains equipment used to control the cluster's internal environment and the workshop electrical power and communications systems.

3) The *multiple docking adapter* provides the docking port for the arriving and departing command and service modules, and contains the control center for the telescope mount experiments and systems. It also houses the Earth applications experiments and materials science and technology experiments.

4) The *Apollo telescope mount* houses a sophisticated solar observatory having eight telescopes observing varying wavelengths from visible, through near and far ultraviolet, to X-ray. It contains the gyroscopes and computers by which the flight attitude of Skylab is controlled. Solar arrays mounted on this module generate about half of the electrical power available to the cluster.

5) The *command and service module* is the vehicle in which the crew travels from Earth to Skylab and back to Earth, and in which supplies are conveyed to Skylab, and experiment specimens and film are returned to Earth.

Skylab will fly in a circular orbit about 436 kilometers (235 nautical miles) above the surface of the Earth, and is planned to pass over any given point within latitudes 50° north and 50° south of the equator every five days. In its orbital configuration, Skylab will weigh over 91,000 kilograms (200,000 pounds) and will contain nearly 370 cubic meters (13,000 cubic feet) for work and living space (about the size of a three bedroom house).

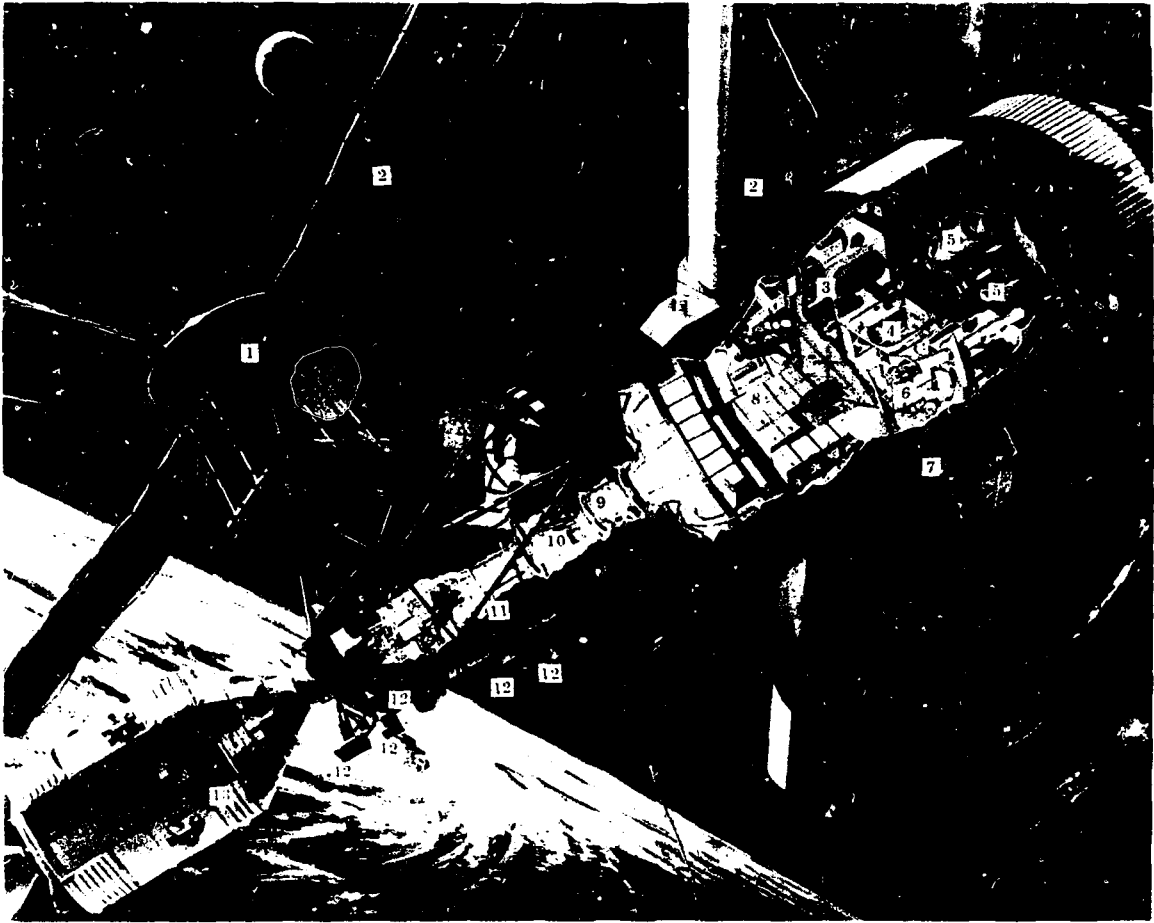

- | | | | |
|---|-------------------------------|----|-----------------------------|
| 1 | Apollo telescope mount | 7 | Orbital workshop |
| 2 | Solar arrays | 8 | Experiment compartment |
| 3 | Sleeping quarters | 9 | Airlock module |
| 4 | Personal hygiene | 10 | Airlock external hatch |
| 5 | Biomedical science experiment | 11 | Multiple docking adapter |
| 6 | Ward room | 12 | Earth resources experiments |
| | | 13 | Command and service module |

Skylab Orbiting Station

Section 1

Introduction

The astronomy and space physics investigations conducted in the Skylab Program include over 20 experiments in four categories to explore space phenomena that cannot be observed from Earth. The shield of atmosphere that surrounds the terrestrial globe absorbs the electromagnetic radiations in the spectral regions of ultraviolet, x-rays, and cosmic rays. Only through conducting investigations in space can these forms of radiant energy be observed and applied to the acquisition of data relating to their sources. While the Sun is the predominant source of energy reaching Earth, radiations from stellar sources are of profound interest because they emanate from many stars that are much hotter than the Sun.

This volume of Skylab experiments considers four categories of space research:

- 1) phenomena within the solar system, such as the effect of solar energy on Earth's atmosphere, the composition of interplanetary space, the possibility of an inner planet, and the x-ray radiation from Jupiter;
- 2) analysis of energetic particles such as cosmic rays and neutrons in near-Earth space;
- 3) stellar and galactic astronomy;
- 4) self-induced environment surrounding the Skylab spacecraft.

THE SOLAR SYSTEM

In Volume 1 of this series, investigations of the solar radiations in the ultraviolet and x-ray wavelengths were discussed. The possible interactions between these radiations and Earth's atmosphere are the subject of an investigation discussed in this volume.

As the ultraviolet and x-ray radiation impinges on Earth's atmosphere, it reacts with oxygen to produce ozone. The concentration of ozone over the Earth varies diurnally and also seasonally to affect Earth climate and weather patterns.

Solar
Effects

Direct connections have been postulated between solar storm activity and major seasonal variations in the Earth's weather. The very severe winter of 1972-1973 experienced by much of the North American continent, in contrast to an unusually mild early winter in higher latitudes is thought by a number of analysts to have been the result of the massive solar storm in August 1972. Greater understanding of the mechanisms involved may lead to gross weather predictions that could minimize losses in crops and livestock such as have occurred during the winter of 1972-1973.

Dust

The space surrounding the Sun, out to the outermost planet, contains vast quantities of matter ranging in size from Jupiter and the rest of the planets and their satellites, through the asteroids located in a belt around the Sun between Mars and Jupiter, to minute particles of dust that may be the debris from cataclysmic events in the past. Little is known of the composition or distribution of this dust; the only information available comes from the reflection or scattering of sunlight by the dust particles. The intensity of the glow caused by these effects is low; therefore much of the information content is lost in absorption in Earth's atmosphere.

Investigations performed in space will permit more precise measurement of the properties of this light so as to provide data on the distribution and characteristics of the dust particles. Particles impinging on the orbiting spacecraft will be trapped and their composition and velocity will be analyzed.

Larger examples of these solid particles have enough energy to enable them to enter Earth's upper atmosphere and a very few (meteorites) even manage to reach the ground. Analysis of the particles trapped by Skylab experiments and comparison with the results of analysis of the meteorites will tell us much about the sources from which these particles may have originated.

Inner
Planets

For over 100 years astronomers have postulated the presence of an inner planet orbiting between the Sun and Mercury. In the 1850's the French astronomer Leverrier identified irregularities in Mercury's orbit that implied another planet.

Jupiter

During the decade of the 1930's Jupiter was found to be a source of radio emission and, subsequently, it was found to possess a very large magnetic field which is thousands of times stronger than Earth's. Because of the magnetic field, Jupiter also has very large radiation belts about it similar to the Van Allen belts of Earth. Extraterrestrial observation of ultraviolet and x-ray radiations from Jupiter will provide vital data in previously unobservable spectral bands.

COSMIC RAY STUDIES

Cosmic rays are the nuclei of atoms. These atoms have been subjected to such extreme stresses that they have been stripped of all or most of their electrons. In this state, these nuclei possess kinetic energies corresponding to millions of electron volts and move at great velocities.

Cosmic rays of low Z-number and similar nuclei from the Sun become trapped by the Earth's magnetic field as they approach the Earth. The magnetic field deflects them from their earthward path into a direction aligned with the magnetic field. This action produces a concentration of these

Z-Number: cosmic rays are classified to the atomic number of the element—Z = 4-helium-alpha particle

nuclei and free electrons in belts called the radiation belts. Collection and analysis of these light nuclei will reveal data on the relative abundance of the basic elements of space and the Sun.

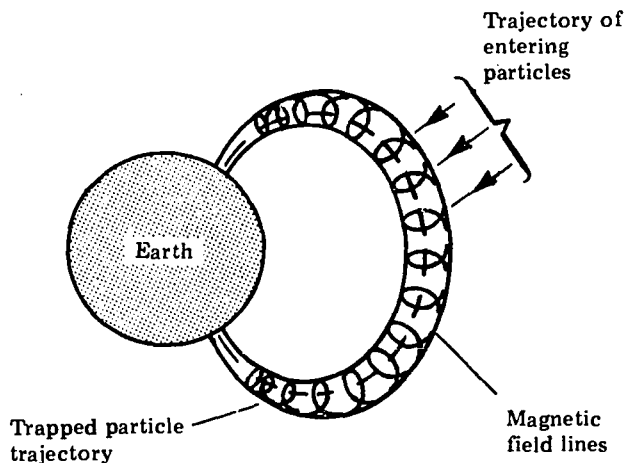

Figure 1-1 Trajectory of Nuclei and Particles as They Become Trapped in Magnetic Field

Cosmic rays of lighter elements, up to $Z=10$, are relatively abundant. Particles up to $Z=26$ (iron), have been detected. Transuranic cosmic rays are those nuclei of elements having higher atomic numbers than uranium ($Z=92$), and so few of these particles have been observed that little is known of their characteristics.

As cosmic rays enter Earth's atmosphere, they rapidly collide with gas molecules that dissipate their energy and prevent them from penetrating to the Earth's surface. Such collisions result in secondary radiation which is absorbed in the atmosphere.

Primary cosmic rays present the only direct samples of the material composition of other galaxies and suns. Comparison of these material particles with cosmic rays emitted by the Sun will reveal considerable insight about the composition of the Milky Way and other galaxies.

STELLAR ASTRONOMY

As one of the oldest of sciences, astronomy has advanced from concepts of an Earth-centered universe to a universe of millions of galaxies. We now know that our solar system is in a remote location in a spiral arm of the Milky Way and that there is a great probability of similar planets in other solar systems of the Milky Way and other galaxies.

Stellar Classes

The early astronomers classified stars in two categories: brightness and color. They called the brightest stars, such as Alpha Centauri, magnitude 0; the magnitude of less bright stars increased to magnitude 6, the limit of naked eye visibility. Although it has been refined, this basic scale is still in use. The brightness difference between successive magnitudes has been defined as a factor of 2.5; thus the brightness difference between 5 magnitudes is approximately 100. Since magnitude 0 is defined by the brightness of a particular star, the magnitudes of other bodies such as the Sun, Moon, and some planets have negative values.

Magnitude

Color

The early attempts at classification by color revealed little information about the star except that it appeared red, or yellow, or white. The development of photometers and spectrometers revealed that a star's color is a measure of its temperature. Ten different major classifications of stars now exist according to color or temperature. Within these classes there are also many subclasses derived from analysis of their spectra. Table 1-1 shows characteristics of the 10 basic types of stars.

TABLE 1-1 Star Spectral Classifications and Examples

TYPE	STAR	APPARENT TEMPERATURE, ° K	COLOR	SPECTRAL CHARACTERISTICS	LUMINOSITY SUN = 1
O	Y Cygni	50,000	Blue	Lines of ionized helium, silicon, nitrogen	36,000
B	Scorpi	25,000	Blue	Lines of oxygen, helium, silicon	2,750
A	Sirius	11,000	White	Lines of calcium, metals	30
F	Capella	7,600	Yellow	Lines of calcium, metals	130
G	Capella	6,000	Yellow	Lines of calcium, neutral metals	130
	Sun				
K	61 Cygni	5,100	Orange	Molecular bands of neutral metals	0.09
M	Betelgeuse	3,600	Red	Bands of titanium oxide, neutral metals	0.008
R&N	19 Piscium	3,600	Red	Strong lines of CN, CH, C ₂	Red variables
S	R Andromedae			Lines of zirconium oxide, lanthium oxide, yttrium oxide	

When the spectral classifications with visual magnitude are plotted on a chart, it is found that a major trend occurs in the chart. Such a chart is the Hertzsprung-Russell diagram in

Hertzsprung-Russell Diagram—a graph of the logarithms of the luminosities of stars plotted against the logarithms of their surface temperatures

which there is a distinct sequence from red, M stars of absolute magnitude 15, to blue stars of magnitude 5. Figure 1-2 is the Hertzsprung-Russell diagram.

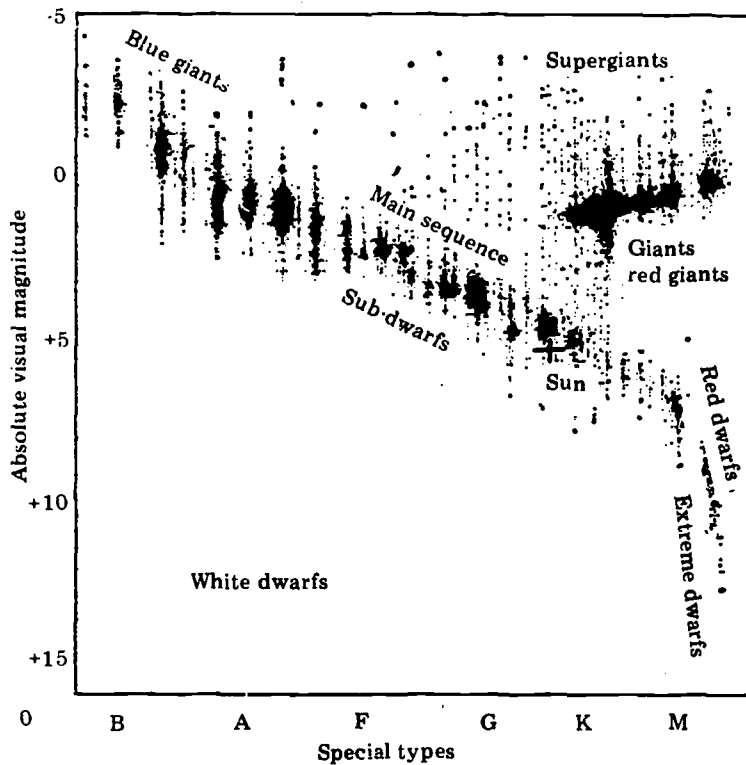

Figure 1-2 Names and General Distribution in the Hertzsprung-Russell Diagram of the Principal Categories of Stars

Life Cycle of Stars

Clouds of interstellar gas and material are thought to concentrate to increasing densities to form new stars. Other stars have been seen to explode as they die, creating novae and nebulae. Still to be determined is the limit of the constantly changing, evolving universe. What is the extent of high energy radiation from the small white dwarfs and what thermal physical mechanisms operate to release these energies? Understanding the life cycle of stars provides a deeper understanding of our own Sun.

Stellar Mysteries
Quasars

The study of quasi-stellar objects is of importance. The quasars emit radio signals of great intensity, and analysis of their visible spectra shows a large red shift, suggesting that they are receding at high velocity (approximately 0.6 to 0.7 of speed of light). Analysis of the ultraviolet radiation of quasars may provide more information on their apparent speed, their distribution in space and their physical structure.

Red Shift—the apparent increase in the wavelengths of light caused by the Doppler effect as the star moves away

Pulsars

Pulsars are believed to be rapidly rotating neutron stars. As such, they represent a new class of star and matter in extreme

physical states. Little is known about their ultraviolet brightness and their relations to other classes of stellar objects.

The stellar astronomy investigations of Skylab will gather data for some of the missing pieces of these puzzles.

SPACECRAFT IN SPACE ENVIRONMENTS

Induced
Atmosphere

The history of space flight has shown that spacecraft in orbit are surrounded by an induced atmosphere. This induced atmosphere is caused by the materials of a spacecraft which emits gases on exposure to vacuum, and from exhaust gases from maneuvering engines. In a manned spacecraft, the gases, vapors and waste products of the astronauts are another major source of the induced atmosphere. The atmosphere expected to accumulate about Skylab has been calculated to be 10,000 times denser than the atmosphere of space.

The effects of this atmosphere are several. The gases may condense on cold spacecraft surfaces, and if these surfaces are paints or coatings for thermal control, they become contaminated and their temperature control characteristics are altered. Condensation on optical surfaces and windows destroys the visibility and effectiveness of optical experiments. Reduced power is the result of condensation on solar panels.

Skylab engineers have made a great effort to minimize and control the induced atmosphere and the resultant contamination. Measurements to be performed will provide information on which to base future spacecraft designs.

RADIATION IN SPACECRAFT

The energy of cosmic rays and energetic solar particles is such that they easily pass through the relatively thin aluminum walls of the spacecraft. As the particles impact the metallic skin, they also cause a secondary radiation of particles of lower Z- numbers and x-rays.

Cosmic and solar particles and x-rays must be monitored because they may be a health hazard to the astronauts. Measurements of radiation levels, from these sources, inside the vehicle will provide design information for future space vehicles.

EXPERIMENT EQUIPMENT

The individual items of experimental equipment used in the investigations will be discussed in later sections of this volume. Several of the investigations, however, require observations in spectral regions to which the Skylab windows are opaque, and other investigations require that the sensors be exposed to the environment outside the spacecraft.

For these observations, two scientific airlocks located on opposite walls of the orbital workshop are provided. One airlock is on the wall facing the Sun in the prime orbital attitude of the spacecraft, the other is on the dark, or anti-solar, side.

The airlocks contain a window through which visible light observations can be made. For observations involving ultraviolet or x-ray radiations, this window is removed before mounting the appropriate experiment equipment. This window is also removed before mounting experiments requiring exposure to the outside environment. The spacecraft pressure integrity is maintained during the periods when the airlock is not in use by a door that is retracted only after mounting the experiment equipment (Figure 1-3.)

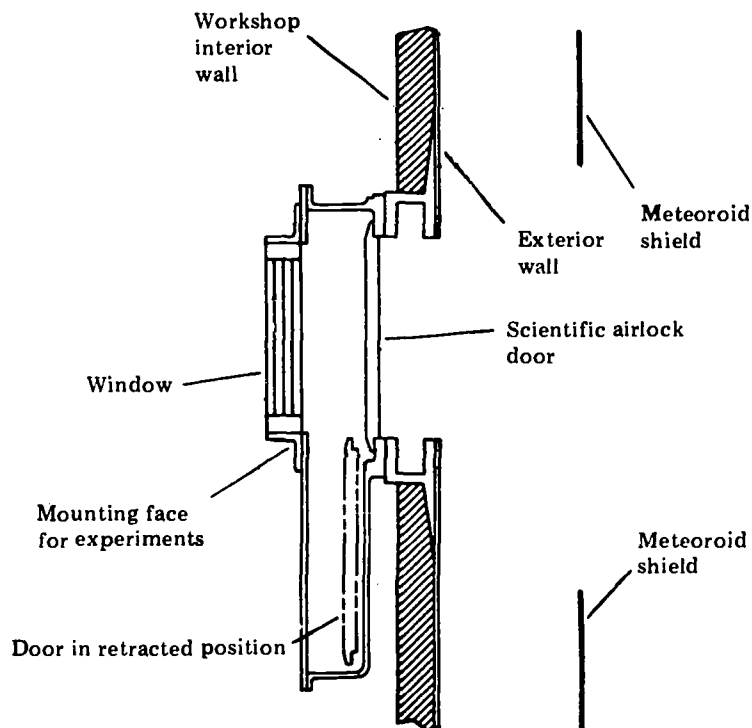

Figure 1-3 Section Through a Scientific Airlock

CLASSROOM ACTIVITIES

Visit the local planetarium, to study the solar system, our galaxy, and other galaxies. Obtain information on the brightness of a number of celestial bodies and relate these to star types. Construct a Hertzsprung-Russell diagram of the bodies studied.

Section 2

Solar System Phenomena

ULTRAVIOLET AIRGLOW HORIZON PHOTOGRAPHY

GEGENSCHNEIDUNG-ZODIACAL LIGHT

MICROMETEOROID PARTICLE COLLECTION

*PHOTOGRAPHY OF LIBRATION CLOUDS

*OBJECTS WITHIN MERCURY'S ORBIT

*X-RAY EMISSION FROM THE PLANET JUPITER

*These experiments were among those selected for flight in the Skylab Student Project.

ULTRAVIOLET AIRGLOW HORIZON PHOTOGRAPHY

EXPERIMENT BACKGROUND

Ozone

Shortly after the turn of the century, it was definitely established that ozone was the constituent in the Earth's upper atmosphere responsible for absorbing solar radiations at wavelengths below about 3000 Angstroms. Ozone is formed when an atom of oxygen, resulting from photodissociation of molecular oxygen by solar radiation, combines with a molecule of oxygen. Distributed between 15 and 70 km, the ozone reaches maximum concentration generally near 30 km. The total ozone above a particular place may vary between 0.2 and 0.5 gm/cm³ (at standard temperature and pressure) depending upon geographic location, the season, and time of day. Ozone occurs on and near the Earth's surface also, being formed mostly by lightning and coronal discharges of various types. It can be detected in local concentrations by its strong characteristic odor, for example, near an arcing electrical motor or other device. Fortunately for mankind, this toxic, corrosive gas is very unstable, being destroyed instantly upon contact with almost everything.

Photodissociation—breakdown of chemical composition by radiant energy

Inasmuch as the production of ozone is directly related to the amount of solar radiation incident upon the atmosphere, it would seem reasonable to assume that the distribution of ozone over the Earth would be a function of the amount of solar energy available; i.e., the greatest amount of ozone would occur over the tropics and vary with latitude according to season. Such, however, is distinctly not the case. The smallest amount of ozone is found over the equatorial belt and varies little with time of year; whereas the greatest amount occurs in the northern hemisphere over the polar regions in the spring and decreases, sometimes by as much as a factor of 2, by autumn. The cause of such anomalous global distribution is ascribed to stratospheric circulation. Air, heated in the tropics, rises through the troposphere, carrying with it ozone from the lower levels of the atmosphere. This ozone, pushed up into the region where photochemical equilibrium exists, is then destroyed by absorption of ultraviolet sunlight below 2900 Angstroms. As the hot air in the tropics rises, it must be replaced by air from elsewhere. In early spring over the polar regions, the air in the troposphere and lower stratosphere is very cold and sinks, taking with it ozone from the stratosphere. This ozone leaves a deficit in the equilibrium region which is quickly made up, and the ozone continues to exist to relatively low levels in the atmosphere as it is screened from the destructive solar radiation by the ozone above it. A pressure differential thus built up by the stratospheric circulation drives air at low levels from the polar regions into the low latitudes, thus completing the global circulation pattern. This upper atmospheric movement is quite slow, with a time constant of about six months, which

accounts for the seemingly anomalous seasonal pattern of global ozone distribution. The preceding is a rather simplistic view and many departures from this distribution pattern exist. This is particularly true for the south-polar regions where wind patterns do not follow those found elsewhere in the global circulation.

Local variations in ozone can be large and rapid. Over areas of high pressure and cyclonic winds the amount of ozone is increased, and over anticyclonic conditions the amount is lower than average. Local weather disturbances, especially severe thunderstorms, may reach into the lower stratosphere and temporarily disturb the equilibrium existing there. Because of the many local atmospheric disturbances scattered over the globe at any given time, it is expected that the ozone would be distributed in cells of varying size and position. An investigation of this fine-grained structure in combination with the large scale ozone distribution by the ozone photography experiment should contribute to a better understanding of global circulation patterns in the stratosphere and how they affect local meteorological disturbances.

Airglow

Travelers in near-Earth orbit can see, on the dark side of the Earth, the thin band of airglow luminescence enveloping the Earth several degrees above the horizon, and extending in all directions. This luminescence results from the release, through photochemical processes, of sunlight trapped by absorption in gases of the upper atmosphere. The visible night glow is confined to a thin shell about 25 km thick with maximum concentration near 95 km above the Earth's surface. It is too dim to be seen when looking up at the zenith sky, but when viewed "edge on", as by the astronauts, the luminosity is enhanced by a factor of 30 or more and the layer becomes visible. The day airglow is completely masked by the strong Rayleigh scattering of sunlight by the lower atmosphere.

Historically, astronomers were the first to be concerned with nightglow because of the fogging of their photographic plates and the superposition of atmospheric lines on their spectra of the stars. Although it was recognized just after the turn of the century that nightglow is an earthly phenomenon, a full understanding of how and where it originated did not come about until 1955 when the Naval Research Laboratory, using rocketborne equipment, first established by direct measurement the altitude distribution of several nightglow emissions. Previously, attempts to determine altitudes from the ground proved not only to be unsatisfactory but sometimes even grossly erroneous.

Rayleigh Scattering—the scattering of light waves by particles with dimensions much smaller than their wavelengths, resulting in angular separation of colors, and responsible for the reddish color of the sunset and the blue of the sky.

SCIENTIFIC OBJECTIVES

The objectives of the experiment are two-fold: (1) to photograph the Earth's ozone layer from above; (2) to photograph

in visible and ultraviolet light certain of the twilight airglow emissions. These seemingly unrelated subjects have a common basis in that both are the direct result of sunlight absorbed in the Earth's atmosphere. The blanket of ozone in the atmosphere protects the Earth's surface from harmful ultraviolet radiation and provides a warm layer in the high atmosphere that contributes to the global circulation scheme in the troposphere and stratosphere. The airglow plays a vital role in maintaining stability in the ionosphere, which is so important to terrestrial communication systems.

Troposphere—the inner layer of the atmosphere, between 6-12 miles, within which nearly all cloud formations occur and weather conditions manifest themselves

The slow drift of air in the lower stratosphere from the equator to the poles has a strong influence on the average amount of ozone over a particular locality. However, local meteorological conditions near the ground also affect the quantity of ozone, particularly near the bottom of the layer, with variations over a short time amounting to a factor of two or more under some disturbed conditions. Although most of these changes occur at relatively low altitudes, violent thunderstorms and hurricanes project their disturbances into the lower stratosphere and should noticeably perturb the ozone balance there.

Tropopause—the boundary between the troposphere and the stratosphere

When observed from satellite altitude, the Earth will appear very dark at 2500 Angstroms. Indeed it should be black, because the strong absorption of ozone in this wavelength region reduces by at least three orders of magnitude the amount of radiation that would otherwise reach an observer because of Rayleigh scattering by the atmosphere. As the wavelength increases toward 3000 Angstroms, ozone absorption is reduced, the solar radiation penetrates deeper into the atmosphere, and the atmosphere becomes brighter. Finally, at wavelengths longer than about 3200 Angstroms, the Earth's surface becomes detectable. Photographs of the terrestrial atmosphere from above, in a narrow wavelength band near 3000 Angstroms, should therefore show patches of varying brightness which would be the result of the solar radiation penetrating to depths that depend upon the amount of ozone in the path of the radiation. This is the primary objective of the ozone portion of the experiment—to photograph the probable patchiness of the ozone and to correlate the nature and distribution of these clouds with pertinent data from ground based observations.

Stratosphere—the region extending upward from the troposphere to about 15 miles above the Earth

Twilight
Airglow

Studies of the twilight airglow from the ground are beset with many difficulties, the principal one of which is the large amount of radiation that arises from Rayleigh scattering in that portion of the atmosphere above the tropopause that is still illuminated by direct sunlight. Added to this is the uncertainty in the corrections to be made for the strong forward scattering stemming from the aerosols and dust between observer and airglow. Extinction in the atmosphere from the

long air path in the direction of view near the horizon requires a calculable correction that may contain hidden errors due to unknown particles in the line of sight. From a station above the atmosphere, however, all of these problems vanish, and reliable data can be obtained.

Noctilucent Clouds

Noctilucent clouds have been observed for many years at altitudes near 82 km at high latitudes in summer (never in winter), but their origin is essentially unknown. They can be seen from the ground only at twilight; whereas from a spacecraft they should be quite visible during daytime as well as twilight. Furthermore, the noctilucent clouds reflect ultraviolet sunlight very well and will appear very bright against the dark ozone background if photographed by chance through the ultraviolet ozone or the Herzberg band filters of this experiment. Red arcs, aurorae, and noctilucent clouds are classified as "targets of opportunity" for this experiment because none of them can be predicted to occur at a given time to permit precise routine scheduling of observations. Notice of a high probability of their occurrence will be available, however, far enough in advance so that if spacecraft geographic location is favorable, a schedule can be sent via teletype to the astronaut observers several orbits before an observation period.

EXPERIMENT HARDWARE

Airglow Photography

Two 35mm cameras will be used, one sensitive to ultraviolet light and using black and white film, and the other sensitive to visible light and using color film. The first has a 55mm focal length, f/2 fused-silica calcium fluoride achromatic lens designed for maximum resolution in the 2500- to 3000-Angstrom wavelength range. The lens for the color camera has a 55mm focal length, f/1.2 aperture, and is a commercial design. Each camera is a single lens reflex-type with an electrically driven timer, shutter, and film transport. The visible camera is fitted with a haze-cutting filter and the ultraviolet camera has a dual filter holder that permits quick interchange of ozone-passing and ozone-excluding filters.

The ultraviolet and visible cameras, the tracking sight, and the ultraviolet transmitting solar scientific airlock window are common to the ozone and twilight airglow portions of the experiment.

Tracking Mounts

For both types of observations, tracking mounts are provided to attach the cameras at their respective windows or airlocks. These tracking mounts allow the cameras to be rotated through the angles required to maintain pointing at any target.

Hydroxyl Emission—radiation of visible light from excited hydrogen atoms (see Volume 1).

Filters

Isolation of various spectral regions will be achieved with special filters. A filter at 2500 Angstroms will transmit the

ultraviolet emission of molecular oxygen. Other filters at 3914, 5577 and 6300 Angstroms will isolate the emissions of ionized molecular nitrogen, atomic oxygen, and hydroxyl airglow, respectively.

SCIENTIFIC DATA

Data resulting from the ultraviolet airglow horizon photography will consist of 35mm photographs. These will be correlated with flight records to determine orbital location with respect to Earth.

The photographs will be analyzed with photo densitometers to determine the intensity of ozone and airglow radiations, their layered structure, and altitude.

Photo densitometer—an instrument to measure the transparency of photographs.

RELATED CLASSROOM TOPICS

Meteorology:

Cyclonic and Anticyclonic Air Currents,
Global Air Currents.

GEGENSCHNEID/ZODIACAL LIGHT

BACKGROUND

Study of the light phenomena referred to by astronomers as gegenschein/zodiacal is related to the study of phenomena occurring in or near the ecliptic plane. The ecliptic is the apparent path of the Sun among the stars, as seen from Earth, projected on the celestial sphere or, more accurately, the projection of the Earth's orbit on the celestial sphere. As shown in Figure 2-1, the Earth's orbital plane is coincident with the ecliptic plane.

Celestial sphere—concept proposed by ancient astronomers consisting of a hypothetical sphere of extremely large radius with the fixed stars lying on the outer boundaries.

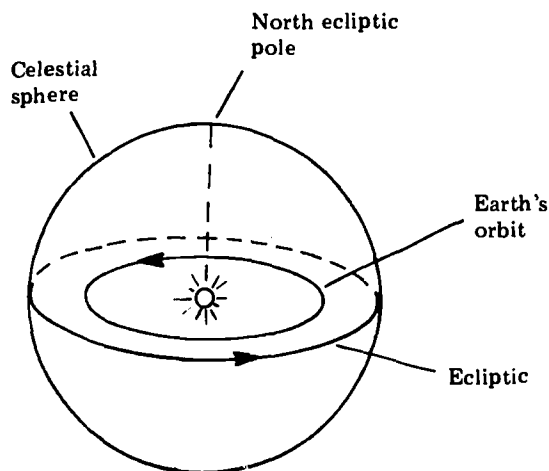

Figure 2-1 Celestial Sphere and Ecliptic

Gegenschein Light

Gegenschein is a faint ecliptical nebulous light about 20 degrees across in the ecliptic plane and opposite the Sun. It is so faint that it can be observed from Earth only in the absence of moonlight. As the Earth moves in its annual path around the Sun, the gegenschein moves along the ecliptic plane, always on the side of Earth away from the Sun. Astronomers generally believe that this light is the result of the back reflection of sunlight from interplanetary material located in a region outside the Earth's orbit.

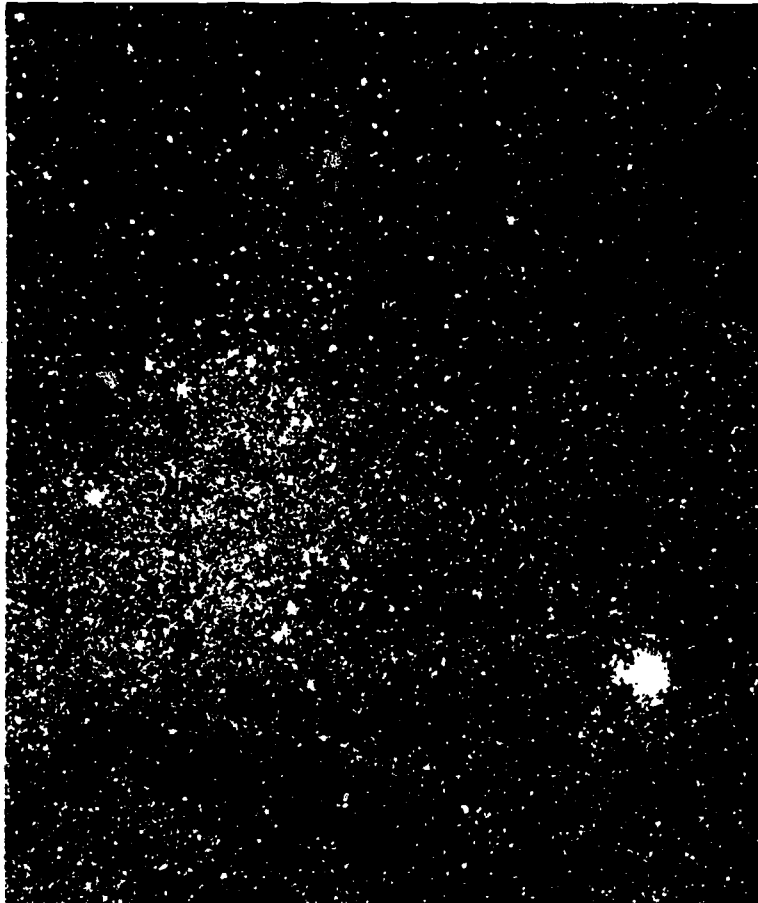
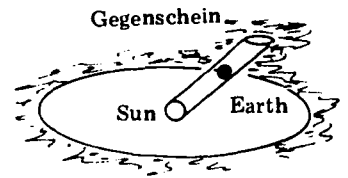

Figure 2-2 Gegenschein

The orbits of all the planets except Pluto are inclined no more than a few degrees from the ecliptic plane. Because of this fact, the planets are generally seen in the sky within a band extending about 8 degrees on each side of the ecliptic. This band is known as the zodiac.

Under suitable conditions, especially when the ecliptic plane is almost perpendicular to the horizon, a triangle-shaped or pyramidal region of faint luminosity is seen in the western sky soon after sunset or in the east shortly before sunrise.

Planet orbital inclinations	
Planet	Inclination, deg
Mercury	7.004
Venus	3.39
Earth	0
Mars	1.85
Jupiter	1.33
Saturn	2.50
Uranus	0.77
Neptune	1.79
Pluto	17.2

SCIENTIFIC OBJECTIVES

This experiment will measure the surface brightness and polarization of the nightglow (zodiacal light, gegenschein, and starlight) over as large a portion of the celestial sphere as possible at several wavelengths in the visible spectrum. The experiment will also be performed at the terminator and with sunlight on the spacecraft to determine the extent and nature of the spacecraft corona.

Terminator—the dividing line between the night and day portions of the Earth.

EXPERIMENT HARDWARE

Gegenschein and zodiacal light will be observed and recorded by a photometer that will extend approximately 17 feet from the Skylab micrometeorite shield. The photometer may be rotated through 360 degrees horizontally and more than 180 degrees vertically, to provide observation of more than a hemisphere of space.

The photometer is comprised of a photomultiplier, with color and polarizing filters. The electrical signals from the photometer are digitally coded and transmitted to ground over Skylab telemetry systems.

The photometer is also used to assess the Skylab-induced atmosphere which is described in Section 5 of this volume.

EXPERIMENT DATA

The data from gegenschein and zodiacal is a function of reflected light seen by the photometer. The data will also include reflected light caused by Skylab-induced atmosphere and contamination. Analysis of the photometer data with respect to its angular position on Skylab will then reveal the intensity of the gegenschein and zodiacal light.

PARTICLE COLLECTION

EXPERIMENT BACKGROUND

The particle collection experiment is designed to collect samples of micrometeoritic dust from the space environment. The erosive effects of micrometeoroids impacting on surfaces of a spacecraft will also be studied.

The space environment of the solar system contains a considerable amount of meteoritic dust which is composed of very small particles called micrometeoroids. The particles of the dust vary in size from 0.5 to 50 or 100 microns. While the dust particles are extremely small, they move at high velocities, causing small craters and gouges in a spacecraft surface

Micron— 10^{-6} meter, 0.000039 inch

A typical grain of sand equals 300 microns diameter.

Micro-
meteoroids

Zodiacal Light

This light extends for several degrees on each side of the ecliptic plane and is known, therefore, as zodiacal light. The most favorable times for viewing zodiacal light at low latitudes in the northern hemisphere are after twilight during March and April and before dawn in September and October. These times correspond to the equinoxes, when the Sun is over the Earth's equator. In equatorial regions, the zodiacal light is visible throughout the year whenever the air is clear.

Zodiacal light is believed to be sunlight on its way to Earth that has been reflected or scattered by interplanetary dust particles, or micrometeoroids, in the plane of the solar system. Most astronomers agree that the zodiacal light phenomenon is an extension of the F-corona (or dust corona) of the Sun. Observed from the Earth's surface, the surface brightness of the light is about 10^{-9} times that of the Sun and about 100 times the integrated brightness of starlight. It is thought that the particles responsible for zodiacal light range in size from 0.03 to 0.0001 cm.

F-Corona—additional coronal region of the Sun, with spectrum resembling that of the photosphere caused by scattering of sunlight from photosphere by fine particles of interplanetary dust.

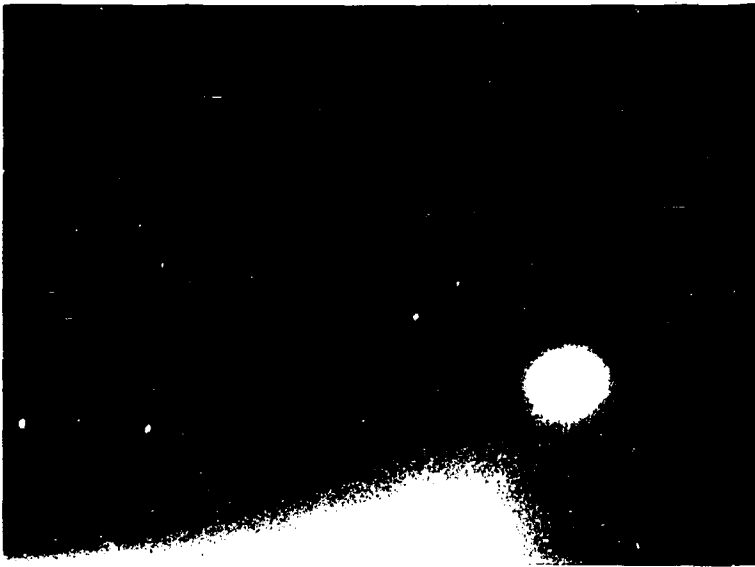

Figure 2-3 Zodiacal Light

Investigations of the zodiacal light have dealt primarily with the brightness and polarization averaged over the period during which the observations were obtained. There has not been a detailed analysis of fluctuations in the zodiacal light radiation field. This is due, in part, to the lack of accurate polarimetric observation until recent years, and more importantly, to the lack of a method of separating daily variations of the airglow from zodiacal light fluctuations.

Airglow—a faint general luminosity in the sky, most apparent at night. This phenomenon is not completely understood by astronomers.

on which they impact. The utility of windows and optical surfaces may be completely destroyed by micrometeoroid impacts. Figure 2-4 shows a crater in an aluminum plate caused by a 100-micron glass bead impacting the plate at 75 km/sec. (Velocities of meteors are from 30 to 150 km/sec.)

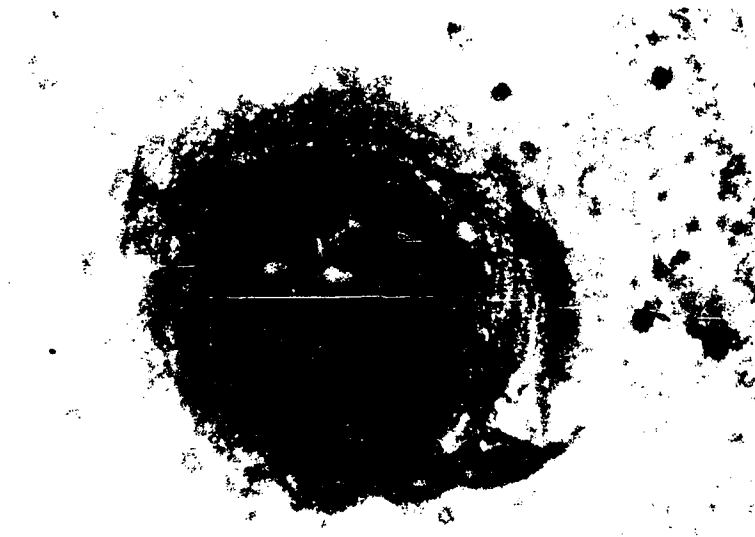

Figure 2-4 Impact Crater in Aluminum Plate

Note: These photos are typical only.

The glass beads were fired from a hypervelocity gun to simulate conditions in space. The crater is 210 microns wide and 96 microns deep. Figure 2-5 is a 700-micron wide by 65-micron deep crater in a glass plate impacted under the same conditions.

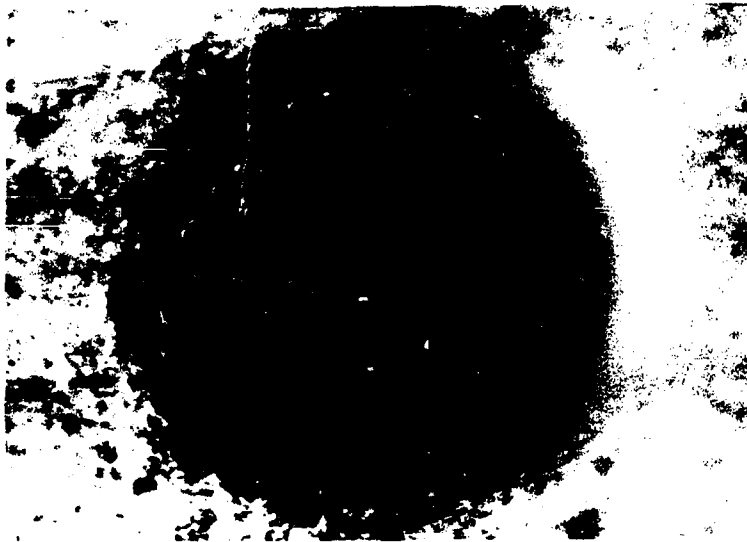
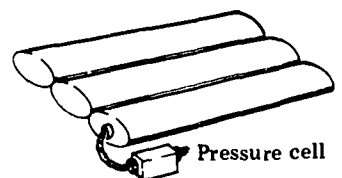

Figure 2-5 Impact Crater in Glass Plate

The presence of micrometeoroids in space is also of interest to astronomers. The reflection of sunlight on the meteoritic dust is thought to be the cause of zodiacal light and gegenschein.

Micro-
meteoroid
Impacts

Various satellites have carried devices to record micrometeoroid impacts. Typical of these devices are pressure cells that lose pressure on penetration, microphones with large sounding plate surfaces, and electrical capacitors that develop short circuits on impact. However, as the satellites do not usually survive reentry, the physical state of the detector cannot be determined and only the impact events are recorded. A few micrometeoroid detector panels were carried on Gemini flights. Figure 2-6 is a photo of a single micrometeoroid impact on stainless steel from a sample on a Gemini flight.



Pressure cell

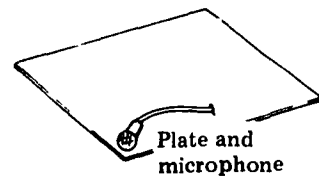
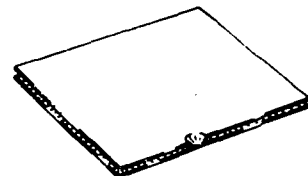

Plate and
microphone



Shorted capacitor

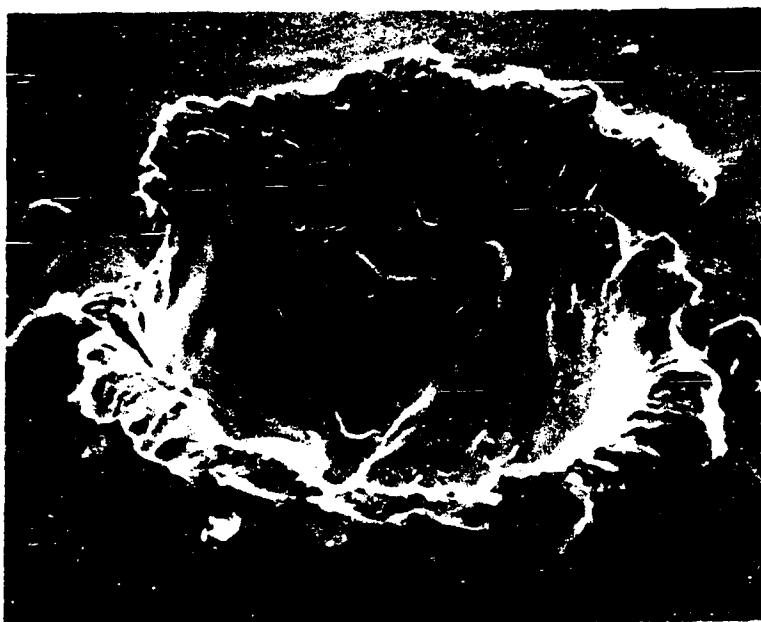

Figure 2-6 Gemini Micrometeoroid Pit

SCIENTIFIC OBJECTIVES

The particle collection experiment has several related objectives. Highly polished metal surfaces of known area will be deployed through a scientific airlock and impact craters incurred on these samples will indicate the mass distribution of micrometeoroids during the time of sample collection. The shape of the craters and their size will indicate the size of the impacting micrometeoroid and the velocity and direction of the collision.

Another type of collecting surface consisting of thin films is designed to trap micrometeoroids. These samples will be ana-

lyzed to determine the composition and structure of the impacting micrometeoroids.

EXPERIMENT HARDWARE

The particle collection experiment uses four cassettes, each of which contains 8 detector panels, with 2 collection samples on each panel. One cassette is deployed at a time.

A cassette holding unit with the cassette in place is deployed through the antisolar scientific airlock by using an extension mechanism to position the cassette approximately one meter from the spacecraft wall. When the extension has been completed, the sides of the cassette holding unit open outward to expose the detector panels and collection samples.

The total exposed area of the deployed collection samples is 1500 cm².

Figure 2-7 shows the deployed micrometeoroid collection system with the collection surfaces extended.

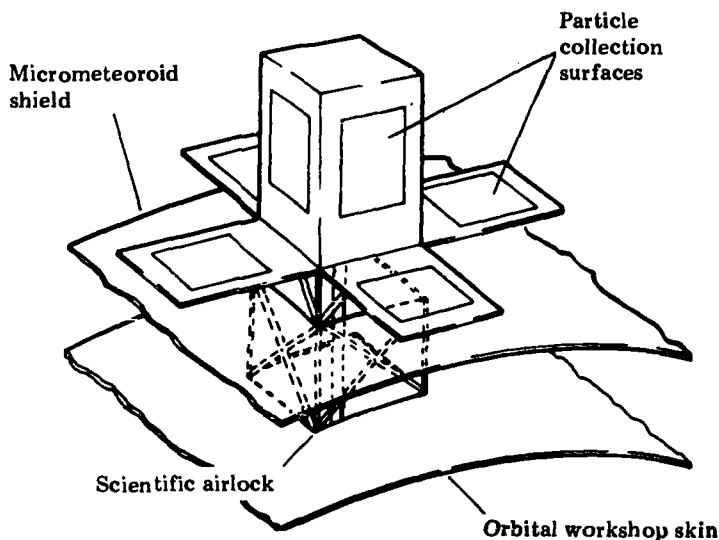

Figure 2-7 Particle Collection Experiment

After completion of the assigned exposure time, the collection surfaces are closed and the unit is retracted into the spacecraft. The exposed samples are packed in a sealed container to prevent further damage to the test surfaces and returned to Earth for analysis.

EXPERIMENT DATA

The micrometeoroid particle collection will be deployed at three different times:

- 1) during the orbital storage period between the first and second manned mission;
- 2) during the second manned mission;
- 3) during the second orbital storage period between the second and third manned mission.

Each deployment period uses a separate cassette. Deployed cassette orientation with respect to Skylab is recorded to obtain directional differences. When the collection samples are retrieved, they are placed in a cassette container for return to Earth.

The impact surfaces will be examined for craters and gouges with an electron microscope. The thin film detectors will be examined for trapped particles that will be chemically analyzed.

Contamination Measurement

A secondary chemical examination will be conducted in support of the contamination measurement experiment (Section 5), for deposits that may accumulate from contamination. Contamination that accumulates during the unmanned, orbital storage periods will be of special interest because this would indicate continued venting of the waste disposal system vapors.

EXPERIMENT CREW ACTIVITIES

The astronaut will place the cassette in the cassette holding unit, install it on the extension boom in the scientific airlock, and extend the boom, following which experiment deployment is automatic.

When the experiment is retracted, the astronaut removes the unit from the extension boom and stores the exposed detector panels and cassette for return to Earth.

RELATED CLASSROOM TOPICS

Classroom topics that are related to this experiment are:

Astronomy

Meteors—origin, orbits, known types;

Chemistry

Procedures for chemical analysis of recovered meteorites.

CLASSROOM ACTIVITIES

Analysis of Impact Craters—Into a bed of some resilient material such as a thick mixture of plaster or a firm gel, drop

spheres (ball bearings) of varying size and mass from varying heights and with varying angles of incidence. Analyze the craters formed to develop a relationship between crater characteristics and the energy of the particles.

NOTES:

1. If plaster of paris is used, all bodies must be dropped at the same time otherwise the stiffening mix will perturb the results obtained.
2. Varying angles of incidence can be achieved by rolling the ball bearings down inclined ramps with the lower ends of the ramps very close to the surface of the bed.

LUNAR LIBRATION CLOUDS

EXPERIMENT BACKGROUND

There are several locations in the two-body, Earth-Moon gravitational system in which the gravitational fields of each body nullify each other. With respect to the two bodies, these are zones of neutral gravity, and a third mass at these locations is not acted on by the other two bodies. These points are called libration points (Lagrangian points) and are illustrated in Figure 2-8.

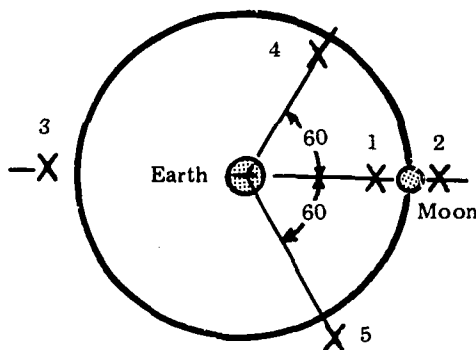

Figure 2-8 Lunar Libration Points

Of the five libration points, points 1, 2 and 3 are unstable because of the relative motion of the binary Earth-Moon system. Locations 4 and 5, however, are stable and move with the prime bodies at points that are equidistant from the Earth and Moon. At these two stable libration points, clouds of dust may have accumulated. These libration clouds may be sources of gegenschein. (There are also congregations of asteroids called "The Trojans" at the libration points of the Sun and Jupiter.)

SCIENTIFIC OBJECTIVES

The lunar libration cloud experiment, one of the Skylab Student Project Proposals, will obtain photographs of the

at angles of 60 degrees ahead and 60 degrees after the Moon in its orbit. The photographs will also be analyzed for variations in these clouds as the Earth-Moon system proceeds around its solar orbit.

EXPERIMENT HARDWARE

This experiment will use data obtained from the white light coronagraph of the Apollo telescope mount (Volume 1, Section 3). The photographs will be obtained when the libration clouds pass within 1.5 degrees of the Sun.

DATA ANALYSIS

Selected photographs from the solar coronagraph that meet the orbital position requirements will be photometrically analyzed for location size, intensity, and polarization of light reflected from, or scattered by, the libration clouds.

OBJECTS WITHIN MERCURY'S ORBIT

EXPERIMENT BACKGROUND

For many years there have been reports of sightings of planetary-like objects lying within the orbit of Mercury. The orbit of such objects would be very near the Sun and extremely difficult to observe.

The greatest elongation of Mercury from the Sun is 30 degrees. Consequently, it is only immediately after sunset or before sunrise that it is visible to the naked eye. To positively sight an object within the orbit of Mercury is very difficult even with telescopes. Thus, reports of such objects are unconfirmed.

SCIENTIFIC OBJECTIVES

The photographs of the solar corona from the white light coronagraph of the Apollo telescope mount (Volume 1, Section 3) will be analyzed for evidence of planetary bodies within the orbit of Mercury. This investigation is another in the series of Skylab Student Project activities.

SCIENTIFIC DATA

The white light coronagraph will provide approximately 30,000 photos some of which may reveal an intra-Mercury body. These will be photometrically scanned for a bright spot indicating the presence of the suspected object.

SCIENTIFIC OBJECTIVES

The x-ray spectrographic telescopes of the Apollo telescope mount (Volume 1, Sections 6 and 7) will be used in an at-

tempt to detect Jovian x-rays to support this investigation proposed by a high school student. These telescopes were designed for solar observations and may not have the required sensitivity to detect x-rays from Jupiter.

In the event of a large solar flare, it will be desirable to observe Jupiter at the appropriate time to see if the solar event may have triggered x ray emission from Jupiter. Such data would have bearing in determining whether Jupiter is dead and receives all its energy from the Sun, or whether it is an active planet generating much of its energy.

SCIENTIFIC DATA

If the telescope is successful in observing Jovian x-rays, photographs of the planet's x-ray radiation will be obtained. These will be correlated with solar data (Volume 1) to determine spectra and intensity of x-rays from Jupiter.

X-RAYS FROM JUPITER

EXPERIMENT BACKGROUND

As the second largest object in the solar system, the planet Jupiter has been a prime object of study for many years. In 1933 it was found to be a source of radio energy. It is also known to have a magnetic field thousands of times stronger than Earth, and x-ray emission has been detected from Jupiter.

SCIENTIFIC OBJECTIVES

The x-ray spectrographic telescopes of the Apollo telescope mount (Volume 1, Sections 6 and 7) will be used in an attempt to detect Jovian x-rays to support this investigation proposed by a high school student. These telescopes were designed for solar observations and may not have the required sensitivity to detect x-rays from Jupiter.

In the event of a large solar flare, it will be desirable to observe Jupiter at the appropriate time to see if the solar event may have triggered x-ray emission from Jupiter. Such data would have bearing in determining whether Jupiter is dead and receives all its energy from the Sun, or whether it is an active planet generating much of its energy.

SCIENTIFIC DATA

If the telescope is successful in observing Jovian x-rays, photographs of the planet's x-ray radiation will be obtained. These will be correlated with solar data (Volume 1) to determine spectra and intensity of x-rays from Jupiter.

AU—astronomical unit equal to mean distance of Earth from Sun

1 AU = 93×10^6 miles (1.496×10^8 km)

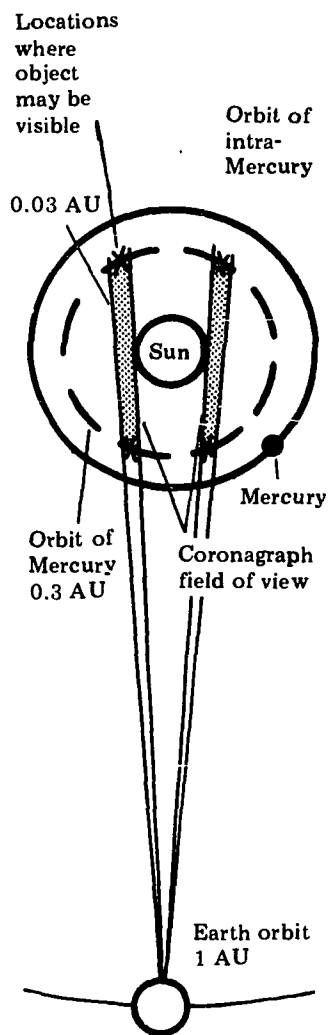

Section 3

The Energetic Particle Environment

MAGNETOSPHERIC PARTICLES

COSMIC RAY NUCLEAR EMULSION

TRANSURANIC COSMIC RAYS

*EARTH ORBITAL NEUTRON ANALYSIS

*This experiment was among those selected for flight in the Skylab Student Project.

MAGNETOSPHERIC PARTICLE COMPOSITION

EXPERIMENT BACKGROUND

Isotopes in Solar Wind

Much of the solar wind radiating from the Sun and its corona is comprised of isotopes and nuclei of noble gases that do not chemically react. As these nuclei enter the Earth's magnetosphere, their trajectories are altered and they become trapped in the upper atmosphere. Determination of the kinds of isotopes, their abundance, and origin in the upper atmosphere is of importance in understanding the influence of solar storms on Earth's atmosphere.

He³, He⁴—isotopes of helium. The superscript indicates the number of electrons stripped from the atom. He⁴ is the helium nucleus and is also known as an alpha particle.

Magnetosphere—the magnetic field of Earth in space

Since the isotopic abundances of helium, neon, and argon are very different on Earth and on the Sun and in the solar wind, particles of terrestrial and solar origin can be distinguished by their relative abundances as tabulated.

<u>Isotope Ratios</u>	<u>Atmospheric Abundance</u>	<u>Average Solar Wind</u>
He ⁴ /He ³	730,000	2400 ± 200
Ne ²⁶ /Ne ²²	9.8	13.6 ± 0.5
Ne ²² /Ne ²¹	34.5	31 ± 3
Ar ⁴⁰ /Ar ³⁶	296	<0.5
Ar ³⁶ /Ar ³⁸	5.32	5.32 ± 0.1

Experiment History

The Apollo lunar flights carried an experiment which measured the composition of the solar wind on the Moon. Sounding rockets carrying this experiment have also been launched into the Aurora Borealis to measure the abundance of He⁴ (alpha particles).

Aurora Borealis—visible light from ionized gases concentrated at the geomagnetic North Pole

SCIENTIFIC OBJECTIVES

The magnetospheric particle composition experiment will measure the integrated flux of charged and neutral particles over four time periods.

The experiment equipment captures the isotopes of the various nuclear species that impact it. Each species has a different energy level depending on its source, galactic nuclei having more energy than solar wind nuclei.

The nuclei are trapped in exposed metal foil. By using aluminum and platinum foils, two sensitivity ranges are obtained. The energy of the impinging nuclei is determined by the temperatures required to liberate the captured isotopes from the foils.

EXPERIMENT HARDWARE

Foil Assemblies

The magnetospheric particle composition experiment consists of aluminum and platinum foil strips fastened to an Armalon fabric backing. The backing is equipped with Velcro and snap fasteners to hold the assembly in place on a mounting spool. Four foil assemblies mounted on two mounting spools are used for this experiment.

Mounting Spools

The mounting spools are installed on tubular members of the airlock deployment assembly truss before launch. The spools are near a handrail used for extra vehicular activities.

Velcro—a two-part nylon fastening fabric. One part is a nap of soft small nylon hooks; the other part is a soft loop pile. When pressed together, the hooks engage the loops for fastening. The soft hooks straighten when separation pull is applied.

Armalon—a Teflon-coated fiberglass cloth

When the Armalon foil assemblies are wrapped around the mounting spool, the foil strips are on the outer surface so that they are exposed to Skylab environments. Figure 3-1 illustrates the manner in which the foil assembly is installed on the mounting spool. The second mounting spool is installed on the same truss member adjacent to the first spool.

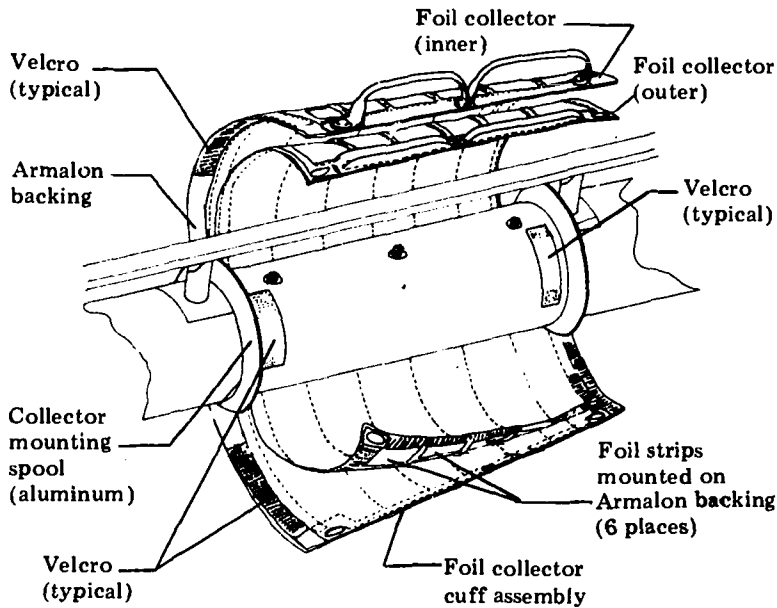

Figure 3-1 Magnetospheric Particle Collector

CREW ACTIVITY

During the second manned mission, the outer foil assembly of one spool will be retrieved during the first period of extra vehicular activity (EVA). The inner foil assembly will be retrieved during the last EVA.

The foil assemblies of the second spool will be retrieved during the two periods of EVA of the third manned mission.

On retrieval, the astronaut will fold the foil assembly with the foil strips inward to protect them from further exposure during Earth return.

EXPERIMENT DATA ANALYSIS

The returned metal foils will be placed in a vacuum chamber and heated. The trapped gas isotopes will then be driven out of the foil and the evolved gas will be analyzed by mass spectrometers.

By increasing the temperature of the samples in a step fashion, the energy of the imbedded isotopes may be determined. Low energy particles will be trapped near the foil surface and will be liberated at a lower temperature than high energy particles which are deep in the foil.

Mass Spectrometer—an instrument which analyzes a gas or vapor according to the atomic mass of its components.

RELATED CLASSROOM TOPICS

Classroom topics in chemistry and physics are relevant to this experiment.

Chemistry

nature, production, and energy of nuclei and isotopes;

Physics

principles and operation of mass spectrometers:
magnetic spectrometers,
radio frequency spectrometers.

COSMIC RAY NUCLEAR EMULSION

EXPERIMENT BACKGROUND

Physics

The cosmic ray nuclear emulsion is designed to record penetration and/or passage of cosmic rays in a photographic emulsion.

Cosmic rays are the nuclei of atoms that have been ionized to the extent that they have been stripped of all, or nearly all, of their electrons. To attain this state, they have been subjected to extreme stresses, e.g., thermal magnetic and electrical. As such they possess large kinetic energies. Since cosmic rays are atomic nuclei, they are material and are not a form of electromagnetic radiation like x-rays.

Classification

Cosmic rays are classified according to the number of protons in their nuclei (atomic number). The classification is represented as a Z-number. Thus, Z-2 is the nucleus of helium

which is also known as an alpha particle. Z-18 is the nucleus of argon and Z-26 is the nucleus of iron.

Sources

Cosmic rays have been found to be of galactic and solar origin. Galactic cosmic rays are generally of the larger Z-numbers, whereas solar cosmic rays are composed of the lighter elements. Solar cosmic rays are associated with solar flares and their flux varies with solar activity.

Flux

The incident flux of cosmic rays on Earth's atmosphere is quite small, of the order of 1 nucleus per 2 seconds per cm^2 . However, interactions with gases in the Earth's atmosphere produce showers of secondary particles that obscure observations from within the atmosphere.

The absorption of the cosmic rays and other forms of radiation in Earth's atmosphere is shown in Figure 3-2.

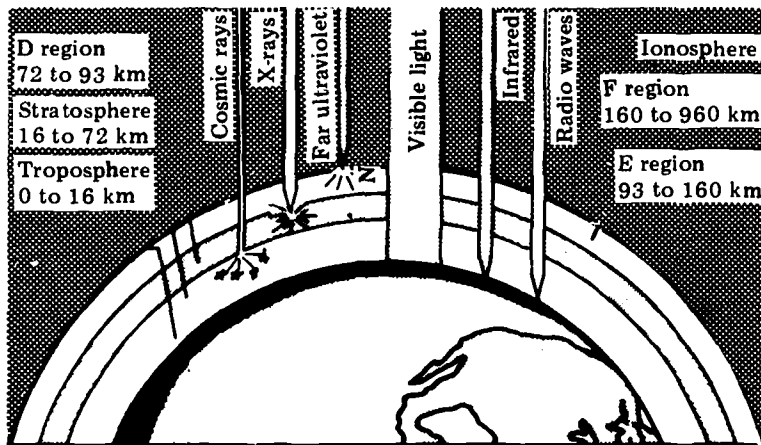

With acknowledgement to the National Geographic Society

Figure 3-2 Atmospheric Absorption of Radiation

Detection

Photographic film emulsions are sensitive to radiations other than visible light. Ultraviolet, x-rays, alpha and beta rays, and cosmic rays will all excite the silver halide emulsions of photographic films.

Radioactivity was discovered through this phenomenon when Mme. Curie found that film protected from light was exposed by a lump of pitchblend stored near the film.

A nuclear emulsion experiment conducted on a Gemini flight measured the abundance of light nuclei of Z values less than 10.

Physics

A photographic emulsion is made of many minute grains of silver halide suspended in a gelatin base and spread uniformly over a transparent film. When energetic photons strike a grain of silver halide, ionization occurs, releasing electrons and causing separation of the silver from the halide. The extent of

the ionization is dependent on the photon flux impinging on the silver halide grain. Ionization may also be caused by charged particles impinging on the film.

After exposure, the emulsion is developed in a chemical bath that acts on activated grains to remove the silver that was separated from the halide and dissolve it out of the emulsion. Thus where photons (light, x-ray, ultraviolet, etc) strike the emulsion the silver is removed leaving the bare film. A second bath, called a fixer, desensitizes the unexposed grains so that any additional radiations will not be recorded.

The cosmic ray nuclear emulsion detector consists of a number of sheets of emulsion in a stack. Figure 3-3 depicts such a stack with cosmic ray particles penetrating it.

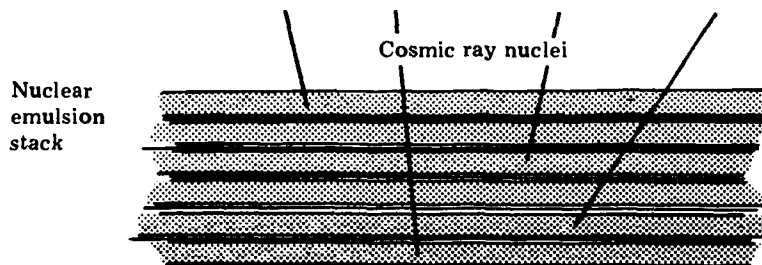

Figure 3-3 Nuclear Emulsion Stack

High energy particles (large Z-numbers) penetrate deeper into the stack. They also present greater photon energy to ionize more silver halide molecules so they will leave darker tracks. Lighter weight particles (low Z-numbers) possess less energy. Thus, they leave lighter tracks and do not penetrate as deeply.

After exposure to cosmic ray particles, the emulsion stack is disassembled and each layer is developed. The layers are examined through a microscope to permit tracing the particle tracks through the emulsion layers. The depth of penetration, the intensity of the particle track, and the angle of the track indicate the kind of particle (Z-number), energy, and direction of travel, respectively.

SCIENTIFIC OBJECTIVES

The objective of this experiment is to record cosmic ray flux outside the Earth's atmosphere. The relative abundance and energy spectra of nuclei with Z values greater than 10 will be determined, primarily in the range 15 to 30. (The abundant iron nucleus, Z-26, is in this range.) Particles with Z values greater than 30 pass through the emulsion and are not captured.

This experiment bears a direct relationship to and will be correlated with the transuranic cosmic rays experiment.

EXPERIMENT HARDWARE

The cosmic ray nuclear emulsion experiment consists of two adjacent stacks of nuclear emulsion. The emulsion differs from photographic emulsion in that it is considerably thicker and has a higher density of silver halide grains to improve the detection of charged particles. The adjacent stacks are hinged together like the two sides of an open book as shown in Figure 3-4.

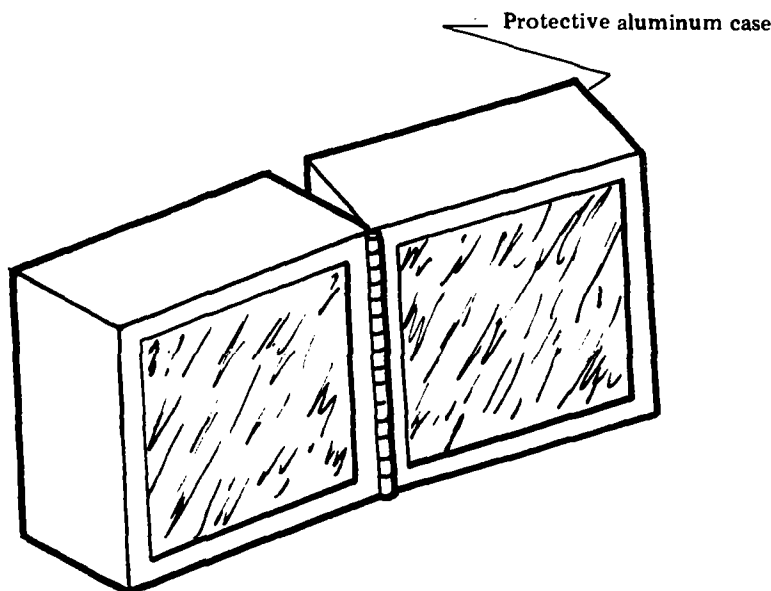

Figure 3-4 Nuclear Emulsion "Book"

During the period of experiment operation, the "book" is open and faces the spacecraft wall, allowing cosmic ray particles that pass through the wall to penetrate the emulsion stack. After operation, the book is closed for Earth return, protecting the stack from additional radiation.

The outside wall of Skylab through which the energetic particles penetrate is 0.125 inch (3.16 mm) aluminum and has a column density of 0.86 gm/cm^2 . The minimum atmospheric column density that balloon flights can achieve is 3 gm/cm^2 . Thus, cosmic ray particles can penetrate Skylab walls and into the experiment much easier than they can penetrate Earth's atmosphere even at high altitudes.

Column Density—mass of a column of given cross section and length. A column of water of 1 cm^2 cross section and 10 gm/cm^2

EXPERIMENT DATA

Upon Earth return, the emulsion stacks will be disassembled and developed, and the layers will be microscopically analyzed for particle tracks. The data will also be correlated with data from the transuranic particle detector to provide a complete cosmic ray spectrum.

CREW ACTIVITY

The cosmic ray nuclear emulsion experiment is essentially passive. However, an astronaut will periodically adjust the position of the experiment with relation to Skylab flight attitude so that the experiment will continue to view the same point in space.

RELATED CLASSROOM TOPICS

Physics

nuclear energies and particles.

Chemistry

photochemical reactions;

Photography

characteristics and sensitivity of photographic emulsions.

TRANSURANIC COSMIC RAYS

EXPERIMENT BACKGROUND

The nucleus of uranium has a Z value of 92. For purposes of the experiment, the cosmic rays of Z number between Z-26 (iron) and Z-92 (uranium) and heavier are referred to as transuranic cosmic rays. Because of the extreme energy required to produce cosmic rays of high Z-numbers, they must be formed in catastrophic events such as supernova explosions. The energy distribution of cosmic radiation indicates that a substantial fraction of the energy production in astrophysical processes occurs in very energetic processes.

Transuranic—pertaining to an element having a higher atomic number than that of uranium.

High energy cosmic rays are the only pieces of matter that we can receive from outside the solar system. Meteors, asteroids, and dust are believed to be of solar system origin. Thus by analyzing the energy and spectra of cosmic rays, we may infer something of the physical processes that occurred in other stars.

Cosmic ray detectors on board Skylab will have a 7-month exposure period at altitudes above the atmospheric absorption region. It is expected that the detectors will record approximately 500 particles of Z greater than 60 (neodymium), 40 particles of Z greater than 90 (thorium), and perhaps 15 transuranic particles of Z greater than 110. At present, so few transuranic particles have been detected that information on the distribution of these particles is limited.

SCIENTIFIC OBJECTIVES

The transuranic experiment will provide information on the relative abundances of nuclei heavier than iron (Z-26) in

Cosmic Rays

cosmic radiation. It is expected that at least 10 times as many transuranic nuclei as have previously been detected will be observed and identified. The energy spectrum of cosmic rays heavier than iron will also be determined in the energy region between 150 and 1500 Mev.

Electron Volts—the energy of an electron or ion accelerated through an electric field of one volt

Mev—million electron volts

EXPERIMENT HARDWARE

The transuranic cosmic rays experiment consists of two identical assemblies containing 18 detector modules. Each module is made of 32 sheets of 0.025 mm (0.01 in.) thick Lexan polycarbonate plastic. The Lexan stacks are 20 x 18 cm (8 x 7 in.) and are wrapped in aluminum foil to meet fire and toxicity requirements.

The detector modules are installed in pockets of a glass fabric harness. The total area of the detector is over 1.3 m² (14 ft²) Figure 3-5 shows the experiment installed in Skylab.

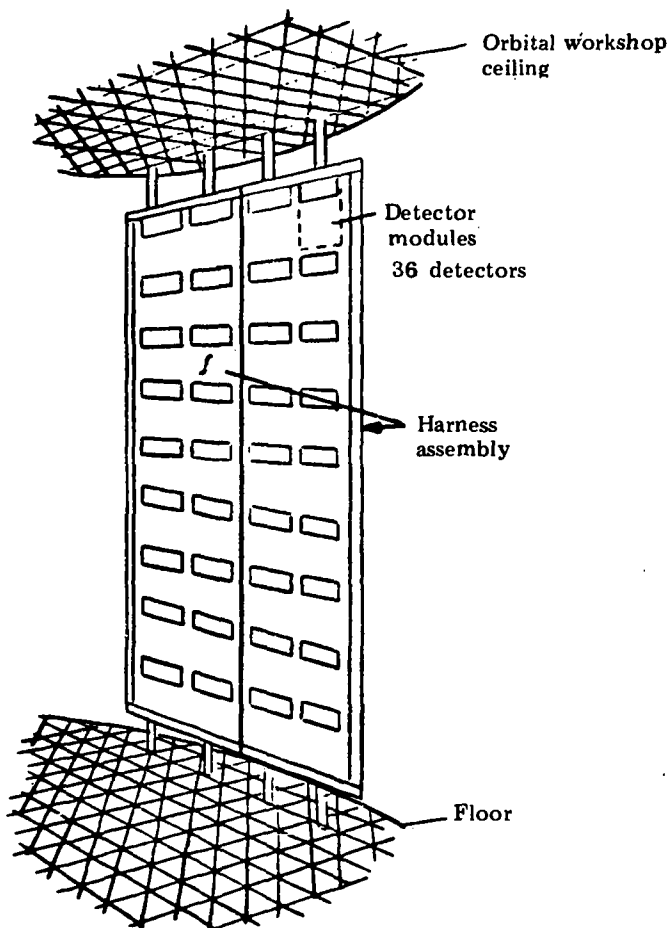

Figure 3-5 Transuranic Particle Detector in Skylab

EXPERIMENT DATA

High energy particles (energy greater than 150 Mev) easily penetrate the aluminum wrapper surrounding the Lexan detector stack. However, on entering the plastic sheets their energy is quickly absorbed by vaporization of the polycarbonate and the particles are stopped.

The depth of penetration into the Lexan sheets indicates the energy of the particle. The cone shape of the hole that is obtained after etching the Lexan sheets indicates mass or Z number of the particle. Some very high energy transuranic particles may completely pass through the modules.

At the end of the last manned mission, the modules are returned to Earth for analysis. The modules are disassembled and the Lexan sheets are chemically etched to show up the individual particle tracks. The sheets are carefully examined with a high power microscope. The data from each Lexan sheet are compared with data of other sheets in the stack to obtain information concerning cosmic ray penetrations.

CREW ACTIVITIES

The transuranic cosmic ray experiment is completely passive. A crewman of the first manned mission will install the harness in the orbital work station.

At the end of the last manned mission, a crewman will remove the modules from the harness and store them for return to Earth.

RELATED CLASSROOM TOPICS

Related classroom topics in physics are:

Wilson cloud chambers,
ionization energies,
topics in nuclear physics.

NEUTRON ANALYSIS

EXPERIMENT BACKGROUND

The neutron analysis experiment is designed to study cosmic rays by detecting the neutrons produced at impact of cosmic rays with atomic nuclei. The experiment seeks to identify those portions of the total neutron flux surrounding the Earth that are attributed to cosmic ray secondary neutrons, solar neutrons, and Earth neutron albedo.

Earth Albedo Neutrons--
neutrons reflected upward (away
from Earth)

Cosmic rays are not rays in the strict sense of the term. They consist of the positively charged nuclei of various atoms that

interact with nuclei in the atmosphere to produce a complex secondary mixture of lower Z particles, protons, neutrons, mesons, gamma rays, and electrons. Those cosmic rays commonly called galactic cosmic rays originate outside the solar system but probably within the local galaxy (Milky Way).

Galactic Cosmic Rays—positively charged particles originating from outside the solar system

Solar cosmic rays, produced by solar flares, interact with the Earth's atmosphere producing lower Z particles, protons, neutrons, and gamma rays but no mesons or electrons. Solar cosmic rays differ from galactic cosmic rays in one important aspect: both the average and maximum energies of galactic cosmic rays are much larger than the energies of solar cosmic rays.

Solar Cosmic Rays—cosmic rays produced by solar flares are of much lower energy levels than galactic cosmic rays

Since the neutrons have no charges, they are free to travel in all directions and can cross the geomagnetic field lines unhindered. Their flux, therefore, may be uniformly distributed in space.

The neutron detector used in this experiment uses the fission theory. When a neutron with the proper energy enters the nucleus of fissionable elements, such as thorium and uranium, fission (splitting) of the nucleus into smaller parts consisting of lighter nuclei occurs. These lighter nuclei, called fission products, are charged and will damage the polymer chains or crystal structure of any appropriate material which is bombarded by these fragments. The damage paths may be chemically etched out and the resulting particle path observed under the microscope. The three sources of neutron flux, e.g., galactic cosmic rays, solar cosmic rays, and Earth neutron albedo, may be identified using the energy selectivity of the combinations of fissionable materials and recording medium in the detector.

SCIENTIFIC OBJECTIVES

The primary objective of the experiment is the measurement of the ambient neutron flux at Skylab orbital altitudes. The experimental data may also reveal information concerning the three contributing sources of the flux, i.e., cosmic ray secondary neutrons, solar neutrons, and the Earth neutron albedo. The data from this experiment will be correlated with that produced by the cosmic ray nuclear emulsion and transuranic cosmic ray experiment to give a more complete picture of the nature and behavior of cosmic rays.

Albedo Neutrons—those neutrons moving upward, away from Earth

EXPERIMENT HARDWARE

The hardware for this experiment consists of ten identical neutron detectors that will be placed in various locations within the workshop by the crew.

The neutron detectors (Figure 3-6) consist of a layer of fissionable foil having panels of uncovered boron (5 B^{10}) bismuth, thorium, and uranium (92 U^{235}). Cadmium-covered uranium and boron foils will be used in conjunction with the uncovered boron, bismuth, thorium and uranium. A film of recording medium consisting of a solid dielectric material (mica and cellulose triacetate) is parallel to the foil. These layers are enclosed in an aluminum housing with a movable aluminum slide. The slide moves between the recording medium and the fissionable material, and, when inserted, intercepts and stops the fission fragments before they reach and are recorded in the recording medium. When the slide is removed, the detector is operative.

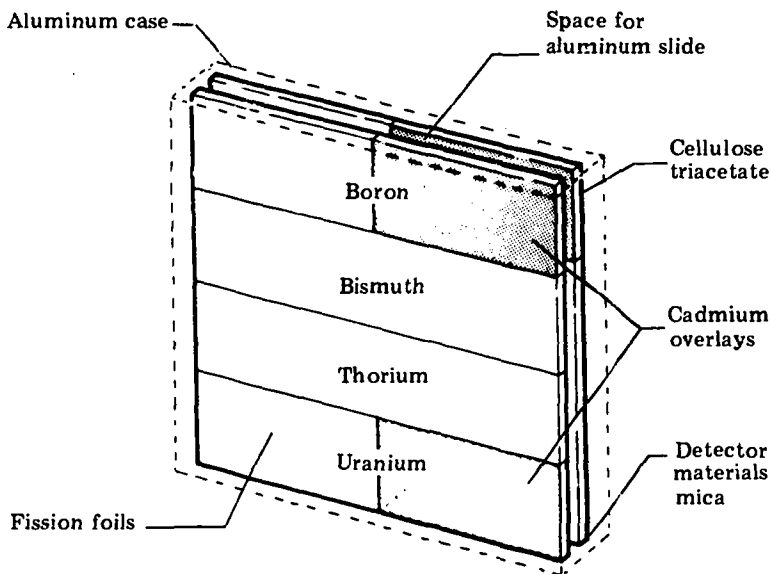

Figure 3-6 Neutron Detector

DATA

The data from the neutron analysis experiment are contained in the returned neutron detectors. After the detectors are returned to Earth, they will be disassembled and the recording medium removed. Using an established method, the neutron damaged paths in the medium will be chemically etched. (The damaged material in the paths will dissolve or react more quickly than the surrounding intact structures.) After etching is completed, the resulting particle paths will be observed under the microscope. By observing the densities of paths behind each type of foil, the energies of ambient neutrons may be identified. When the energies are known, the sources of neutrons may be identified.

CREW ACTIVITIES

The astronauts will remove the ten detectors from their launch stowage locations and install them in their on-orbit

locations. Four of the detectors will be placed adjacent to one of the water storage tanks in the workshop and the other six at various other locations within the workshop. The water in the tank will moderate or thermalize some of the high energy neutrons. After the astronaut installs the detectors, he will activate each one by removing the aluminum slide. Four of the detectors will be removed and returned to Earth at the close of the first mission. The remaining six detectors will be returned after the last mission.

Section 4

Stellar and Galactic Astronomy

ULTRAVIOLET STELLAR ASTRONOMY

ULTRAVIOLET PANORAMA

GALACTIC X-RAY MAPPING

*SPECTROGRAPHY OF SELECTED QUASARS

*A SEARCH FOR PULSARS IN THE ULTRAVIOLET WAVELENGTHS

*X-RAY CONTENT IN ASSOCIATION WITH STELLAR SPECTRAL CLASSES

*These experiments were among those selected for flight in the Skylab Student Project.

ULTRAVIOLET STELLAR ASTRONOMY

EXPERIMENT BACKGROUND

Historical

Ultraviolet studies of stars from ground observatories are prevented by Earth's atmosphere which acts as a filter to absorb ultraviolet radiations shorter than 3000 Angstroms. The hottest stars, class O, B, produce ultraviolet emissions of which 80 percent are shorter than 3000 Angstroms. Thus, only a very limited amount of this stellar data can be studied from Earth.

Sounding rockets and the Orbiting Astronomical Observatory (OAO) have been used extensively to achieve an ultraviolet view of the skies. However, these flights have provided spectra of only 30 stars.

Stellar Magnitudes—system of measuring stellar brightness with 0 the brightest star, magnitude 6 is faintest for naked eye visibility. The difference between stars of successive magnitude (i.e., 3rd and 4th magnitude) is 2.5, so that the difference over 5 magnitudes (1st to 6th mag) is approximately 100. Four planets, Moon and Sun have negative magnitudes.

Physics

The Ritchey-Chretien telescope is a derivation of the Cassegrainian telescope system which uses reflecting optical surfaces. The usual design for reflecting telescopes uses mirrors that are parabolic sections and characterized by relatively long focal length and narrow field of view. The Ritchey-Chretien system uses hyperbolic sections resulting in a shorter focal length and broader field of view. These features make for a more compact telescope design and permit a larger area of the sky to be seen at one time.

The ultraviolet stellar astronomy experiment will provide spectra of hundreds of stars. It will view stars 3 magnitudes fainter than those obtained by sounding rockets.

SCIENTIFIC OBJECTIVES

The primary objective of ultraviolet stellar astronomy is to obtain moderate dispersion stellar spectra ranging from 3000 to 1400 Angstroms. Sufficient resolution will be provided to permit the study of ultraviolet line spectra in early type stars.

Low Dispersion—spectrum spread to 10,000 Angstrom/mm

Photographs (150) of low and moderate dispersion on numerous star fields will be obtained.

Moderate Dispersion—spectrum from 1300 to 5000 Angstroms spread to 300 Angstrom/mm average

A secondary objective is to obtain low dispersion ultraviolet spectra of star fields in our own galaxy, (Milky Way) and in other nearby galaxies.

EXPERIMENT HARDWARE

The ultraviolet stellar astronomy experiment is comprised of three major components. These are the articulated mirror system, the telescope optical system, and the film canister. The articulated mirror system is also used for the ultraviolet panorama experiment (Section 3). A viewfinder telescope and focusing microscope are operational accessories to the experiment.

In operation, the ultraviolet astronomy experiment is installed in the antisolar scientific airlock. In order to achieve a field of view other than a straight line-of-sight through the scientific airlock, a rotatable or articulated mirror is used as in a periscope. The mirror is extended approximately 43 cm (17 in.) out from the spacecraft skin. The mirror can be tilted through 15 degrees about a horizontal axis to provide a 30-degree elevation range. It may also be rotated through 360 degrees about the instrument axis. This system permits selection of many stellar subjects, without a need for Skylab maneuvers.

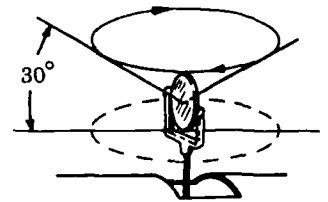

Figure 4-1 shows the optical plan of the Ritchey-Chretien telescope system.

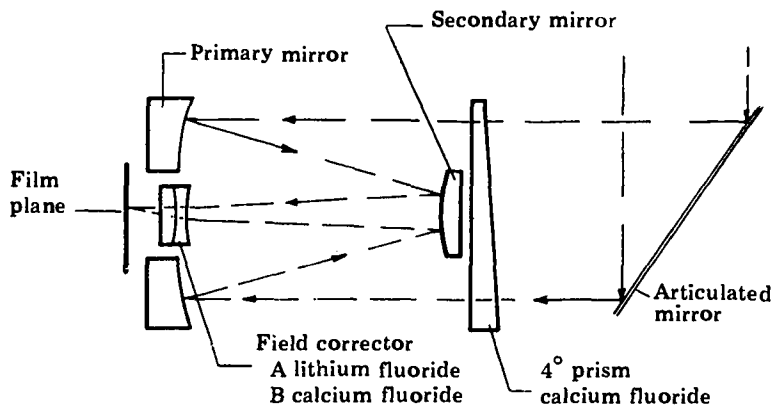

Figure 4-1 Optical Plan

This telescope has a 45.6-cm (18-in.) focal length with a 15.25-cm (6-in.) aperture. The field of view is 5 degrees. Because of the short focal length and wide field of view, off-axis stellar images are slightly defocused.

The two-element field corrector lens provides the low dispersion spectral characteristics of the telescope. To obtain the required chromatic correction and allow ultraviolet transmission in the field corrector lens, one element is made from lithium fluoride (LiF) and the other from calcium fluoride (CaF²). (Glass field corrector elements would limit the spectrum to 3000 Angstroms.) The combination of materials is used to obtain a refractive index that is different from the two separate materials and will provide the desired chromatic corrections.

Moderate dispersion spectra of stellar objects are obtained by interposing a 4-degree dispersing prism between the telescope and the articulated mirror system. The prism will provide dispersion such that at 2000 Angstroms the resolution will be 9 Angstroms, and at 3000 Angstroms it will be 1500 Angstroms. The dispersing prism is fabricated of calcium fluoride to provide the required ultraviolet transmission.

Many emission lines will be detailed at this resolution, and the primary objective of the program will be to study the variations in these lines from star to star.

Since stars always appear as point sources of light even in a telescope, spectroscopic images appear as dashed, colored lines. However, in the stellar ultraviolet experiment, a mechanism is provided to shift the film in a direction normal to the image during photography. This motion provides spectrum widening which results in the band shown in Figure 4-2.

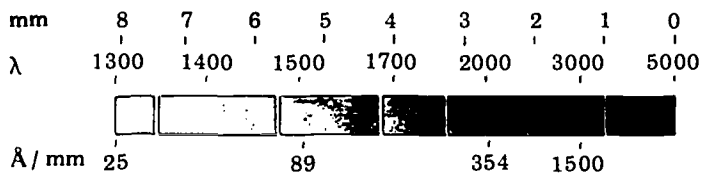

Figure 4-2 Spectrum of Stellar Astronomy Experiment

The film canister of the ultraviolet stellar astronomy experiment contains the film slides and associated mechanisms to focus, count, expose, and change the film.

A separate viewfinder telescope, focused on the articulated mirror, permits the astronaut to select the desired stellar subject by adjustment of the mirror position.

EXPERIMENT DATA ANALYSIS

The data obtained from the ultraviolet stellar astronomy will permit detailed physical analysis of the ultraviolet radiations of hundreds of individual stars. Special emphasis is being placed on a search for previously undetected anomalies in the physics of stars.

Figure 4-2 shows the spectrum, spectral dispersion, and resolution that will be obtained with the experiment. Figure 4-3 shows how a typical star field is recorded in the ultraviolet stellar astronomy experiment. This photograph was recorded with the prototype instrument on the Earth. The 3000-Angstrom absorption of the atmosphere is clearly evident in this photo.

CREW ACTIVITY

The ultraviolet stellar astronomy experiment will be performed during all three manned missions. Fresh film will be supplied on each visit.

The astronaut will fasten the articulated mirror system to the ultraviolet stellar astronomy experiment and install the

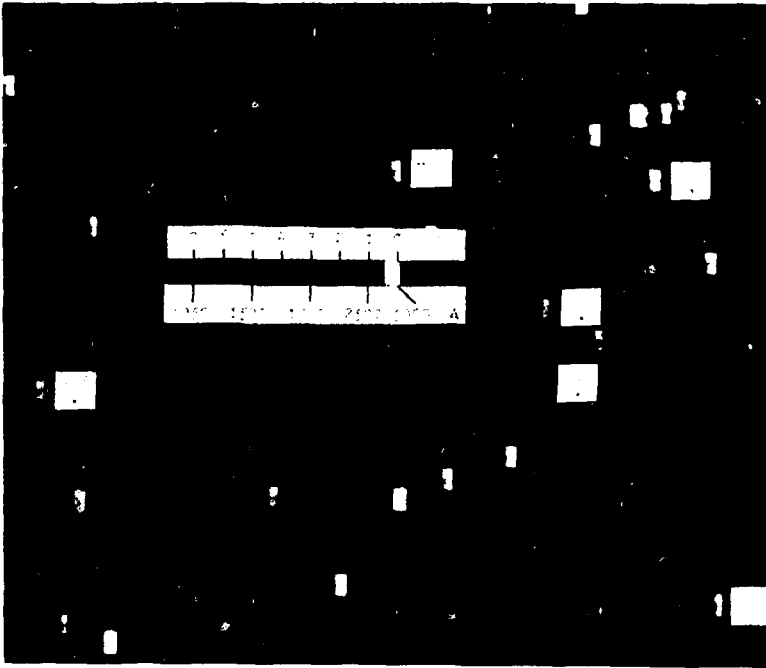

Figure 4-3 Typical UV Spectra of a Star Field

assembly in the antisolar scientific airlock. When the airlock has been opened, he will extend the articulated mirror. Using the viewfinder he will position the articulated mirror to the desired star field and perform the required experiment operations.

RELATED CLASSROOM TOPICS

Classroom topics in astronomy and physics are related to this experiment. Subjects for discussion are:

Astronomy

stellar magnitudes, relative brightness,
types and classification of stars,
stellar evolution,
Hertzprung-Russel diagram;

Physics

optics

refracting vs reflecting telescopes,
index of refraction,
compound lenses.

CLASSROOM ACTIVITY

- 1) Discussion of optical transmission characteristics of window glass, fused quartz, lithium fluoride, and calcium fluoride.
- 2) Spectroscopic analysis of visible light: using a spectroscope, set up, as illustrated in *Physics-Advanced Topics Supplement*, PSSC 1966, pp 164 and 165, or as shown in Volume 1, Sections 4 and 5 of this series, perform spectral analyses of various visible light emitters. What are the spectral differences between 20-, 40-, 60-, 75-, and 100-watt incandescent light bulbs, and between these and comparable fluorescent light bulbs?

Also burn various materials such as potassium chloride, calcium chloride, sodium chloride, copper chloride, and perform spectral analyses of the light emitted.

ULTRAVIOLET PANORAMA

EXPERIMENT BACKGROUND

Astronomical

Study of stellar ultraviolet radiation in wavelengths shorter than 3000 Angstroms from Earth has not been possible because of absorption in the atmosphere. However, it is in this range of the spectrum that the hot massive stars appear to emit the largest amount of their energy. Since these hot stars are thought to form in the clouds of gas and dust in the Milky Way where the process of stellar formation is occurring, it is important to understand them to learn how stars and planetary systems are formed.

Broadband photometry (or measurement of the intensity of the radiation emitted) in the ultraviolet range is a fundamental measurement in the study of hot stars. Photographic recording enhances data collection because many stellar images are simultaneously recorded on a single photographic plate permitting analysis of star clusters and nebulae as well as individual subjects.

Photometry—systems of light measurement employing photographic principles.

Physics

The most accurate stellar photometry is performed by using a spectral image of the star rather than a direct stellar image. Various systems are employed to obtain spectral data. Several of these are explained in Volume 1 of this series. In particular, various types of diffraction gratings to resolve spectra are discussed in Volume 1, Section 4.

The ultraviolet panorama experiment uses a diffraction grating to obtain diffracted stellar images, in conjunction with a unique "insect eye" lens, which is a mosaic of cylindrical and spherical lenses.

Figure 4-4 illustrates the basic concept in which an array of cylindrical lenses is used. Figure 4-5 shows the imaging format from spherical lens array.

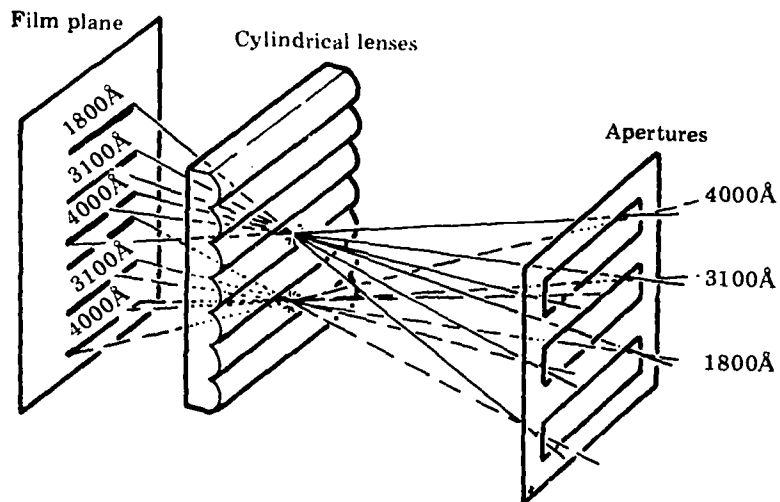

Figure 4-4 Concept of Cylindrical Lens Array

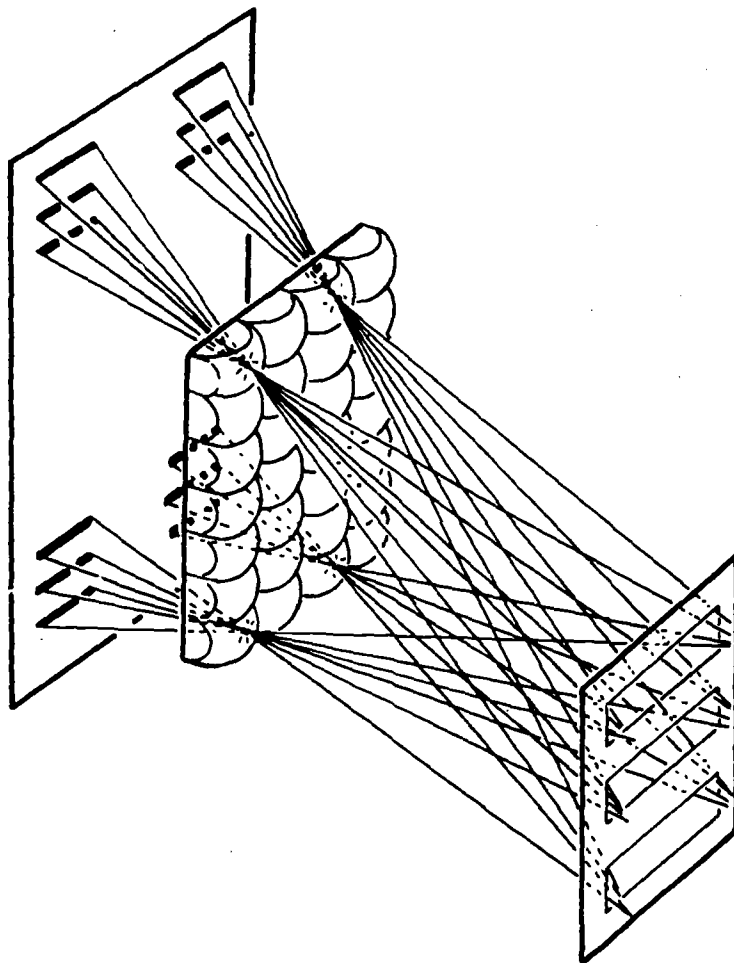

Figure 4-5 Imaging Format from Spherical Lens Array

Light of three different wavelengths shining through three corresponding slits in an aperture mask, is focused on the front surface of an element of a cylindrical lens array. The lens then acts to transmit the images of the three apertures separately to the film plane.

If light shines on the apertures from a different angle, images of the apertures will be focused on a different element of the cylindrical lens array. This lens will transmit the images in the apertures as three separate images to the film plane.

Each cylindrical element transmits its images to the film plane independently of the other elements. The form of the image produced by this lens system is known as a Fabry image.

SCIENTIFIC OBJECTIVES

One of the principal methods of classifying stars is the ultraviolet-blue-visible (UBV) system. This method sorts Type O, B, and A stars according to their spectral location in the UBV system. In the far ultraviolet, wavelengths of principal interest in photometry are at 1800 and 3100 Angstroms.

The ultraviolet panorama experiment will study hot stars in various areas of the Milky Way. Spectrophotometry in the spectral regions at 1800 and 3100 Angstroms will be used to obtain the color indices of more than 1000 stars.

A secondary objective of the ultraviolet panorama is to determine the appearance in spectral bands centered on 1800 and 3100 Angstroms of star clusters, stellar clouds in the Milky Way, and nuclei of brilliant galaxies. The integrated magnitude of these clusters provides an important parameter in the statistical study of stellar evolution.

Integrated Magnitude—the magnitude of a star cluster, the sum of the component Stars.

EXPERIMENT HARDWARE

The ultraviolet panorama experiment is a spectrographic camera. In operation, it is installed in the antisolar airlock so as to view selected star fields of the Milky Way and other galaxies. The field of view of the camera is 7 x 9 degrees so as to record broad sky views.

Light from the selected star fields is transmitted through the scientific airlock by means of the articulated mirror system. This system is discussed in the description of the ultraviolet stellar astronomy experiment.

Light from the articulated mirror enters the system through an entrance pupil to limit the field of view to the desired size. The light then passes to a plane mirror and an elliptic mirror

which focuses the light on a plane grating. The grating is ruled at 610 lines/mm and blazed at 1750 Angstroms.

Blaze—the shape of the grooves in a diffraction grating; determines the spectral efficiency of the grating. (See Volume 1, Section 4.)

Figure 4-6 illustrates the optical scheme of the ultraviolet panorama experiment.

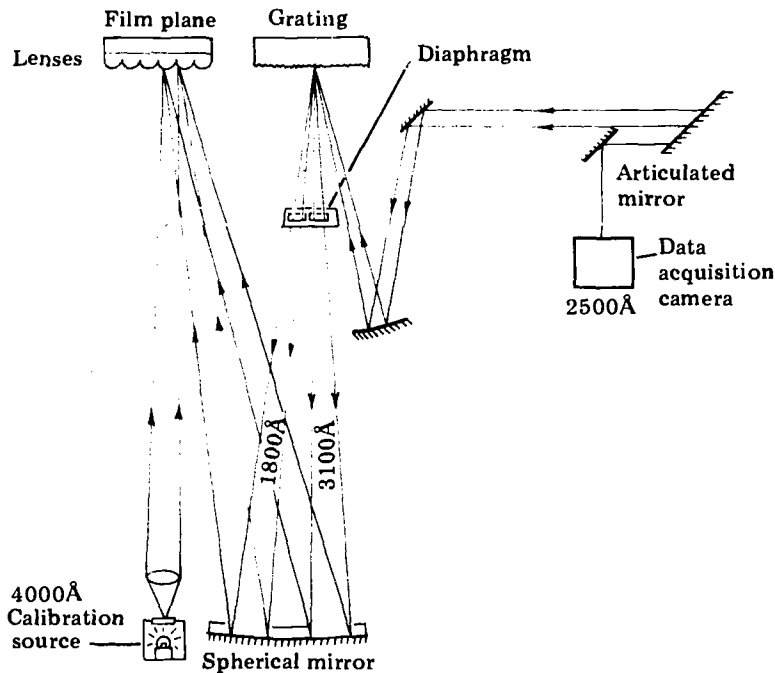

Figure 4-6 Optical Scheme of Ultraviolet Panorama

The diffracted light spectrum is passed through a diaphragm with two apertures located in the spectrum so as to pass only 600 Angstrom-wide bands centered at 1800 and 3100 Angstroms.

The two spectral bands of diffracted light are reflected and focused onto the front surface of the insect eye mosaic lens. Half of the mosaic contains spherical lenses and the other half cylindrical lenses. Figure 4-7 depicts the configuration of the mosaic of spherical and cylindrical lenses.

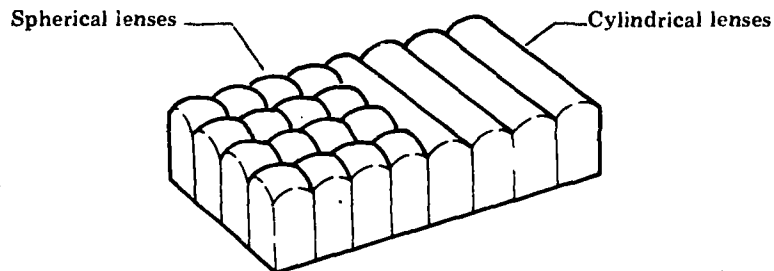

Figure 4-7 Lens Mosaic

In addition to the spectral bands from the diffracted starlight, a calibration source of 4000 Angstroms is also focused on the lens mosaic. Thus, each element of the mosaic lens array registers calibration marks and the two bands of spectral data that fall on it.

Figure 4-8 depicts the appearance of a direct photograph of a nebula and star field. In comparison, Figure 4-9 shows typical data obtained with the ultraviolet panorama experiment.

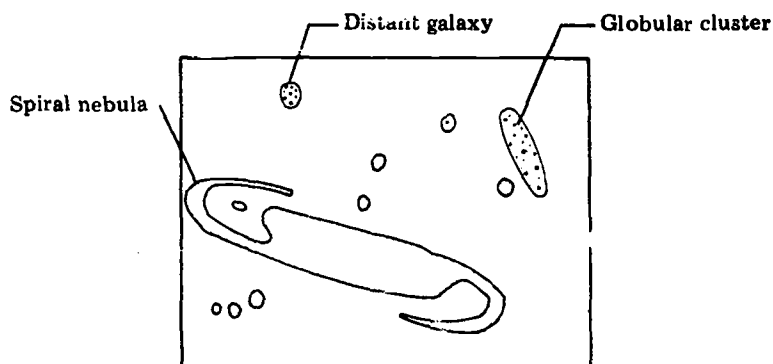

Figure 4-8 Direct Photography

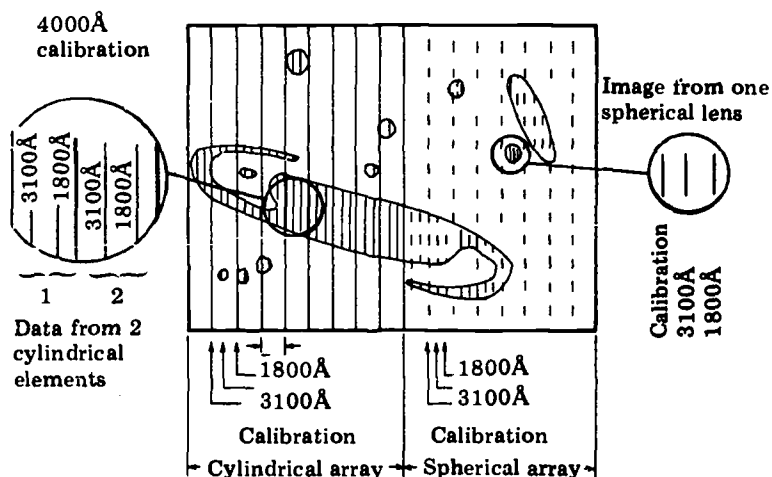

Figure 4-9 Typical Data

A viewfinder telescope and a data acquisition camera complete the equipment hardware. The viewfinder enables the operating astronaut to position the articulated mirror system and select the subject star field for study. The data acquisition camera also provides direct photography of the selected star fields in a spectral band centered at 2500 Angstroms for comparison with the experiment data photographs (as shown in Figures 4-8 and 4-9).

EXPERIMENT DATA

Spectral data in three bands centered at 1800, 2500, and 3100 Angstroms of 24 selected star fields containing over 1000 stars will result from this experiment in 150 photographic plates. This data will also be correlated with that from the ultraviolet stellar astronomy experiment that will be of the same star fields in many instances.

The final analysis will form the basis for further definition of color indices and classification of stars of types O, B, and A, which are young, bright hot stars in the stellar evolution cycle.

CREW ACTIVITIES

A crewman will install the ultraviolet panorama experiment and articulated mirror system in the scientific airlock and will mount the French-built ultraviolet spectrophotometer equipment. Using the viewfinder, he will then position the articulated mirror to view the desired star field and operate the experiment. The experiment is always performed on the night side of an orbit to eliminate light scattering from sunlight.

RELATED CLASSROOM TOPICS

Classroom topics in astronomy and physics can be related to this experiment.

Astronomy

- classification of stars and colors,
- Hertzprung-Russel diagram of stellar types and stellar evolutionary progression,
- luminosity of stars;

Physics

- optics
 - diffractions gratings,
 - spherical and elliptic mirrors,
 - lenses—ray tracing.

CLASSROOM ACTIVITIES

Spectroscopic Analysis of Star Fields—Using a home-built astronomical telescope and the spectroscopic technique described in *Physics-Advanced Topics Supplement*, develop spectrographs of star fields. What can be learned about the composition and temperatures of the stars in the field of view?

GALACTIC X-RAY MAPPING

EXPERIMENT BACKGROUND

X-ray Sources

The galactic x-ray mapping experiment is designed to locate and analyze the spectra of celestial x-ray sources.

X-ray radiating stars are representative of white dwarfs, supernovae remnants, neutron stars, and black holes. More than one hundred separate x-ray sources have currently been cataloged. Most of these sources are in our galaxy. These sources have been discovered through satellites and high altitude sounding rockets, since x-rays do not penetrate the Earth's atmosphere to be observed on the ground.

When an x-ray source is discovered, the data is correlated with visual and radio observations, so that the relationship of the x-ray source and known stellar objects may be defined. The intensity and spectra of the x-ray radiation also provide indications of the radiation characteristics of the x-ray source.

A continuous background of x-rays that may be present could arise from the interaction of cosmic rays with the material in interstellar space.

SCIENTIFIC OBJECTIVES

The x-ray galactic mapping experiment will survey a large portion of the sky for x-ray sources of energies ranging from 200 to 20,000 electron volts. The location, intensity, and spectrum of each source will be determined. The possible existence of a continuous x-ray background will also be verified.

EXPERIMENT HARDWARE

An array of 10 proportional counter tubes is used to sense the x-ray radiation.

Proportional counter tubes are diodes filled with a low pressure gas mixture. A metallic window in the end of the tube admits x-ray photons into the tube. As the photon enters the gas mixture of the tube, it ionizes some of the gas molecules causing the released electrons to be attracted to the anode of the tube and the positive ions to be attracted to the cathode. Photons with greater energy cause more ionization so that the current output from the tube is proportional to the photon energy penetrating the window. The proportional counter tube is also discussed in Section 8 of Volume 1 as part of the description of the solar x-ray event analyzer experiment.

Galactic x-rays are much less intense than solar x-rays. Therefore, the metallic window of the proportional counter is a thin metal foil so that low energy photons of 200 electron volts energy may enter the tube.

The array of counters is built in a manner that allows a thin metal foil to serve as a common window for the proportional counters. Figure 4-10 illustrates the configuration of the proportional counters. A segmented base provides a common cathode for the ten counters. Separate anodes detect the resulting current pulses in each segment and a thin membrane over the array permits penetration of x-rays to all segments.

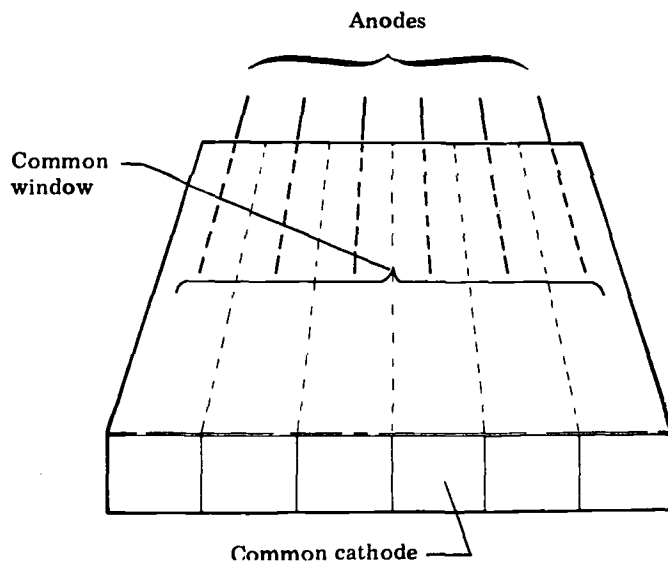

Figure 4-10 Proportional Counter Array

Pulse Height
Analyzer

Each of the proportional counters is connected to the input of a 5-channel pulse height analyzer that will sort the current pulses at its input connection into any of five separate channels according to pulse amplitude. Since the current pulses from the proportional counter are dependent on the photon energy of x-rays entering the counter, the pulse height analyzer provides five intervals over the range of 200 to 20,000 electron volts of x-ray energy. By counting the number of pulses at each output of the pulse height analyzer, the intensity of the x-ray energy in the five spectral ranges may be determined. The operation of pulse height analyzers is treated in detail in Volume 1, Section 8.

Booster
Installation

The galactic x-ray mapping experiment is installed on the booster stage which is used to place the command module with three astronauts into orbit. After orbit is achieved, the spent booster is separated from the command module and enters a separate orbit, becoming the platform from which the galactic x-ray mapping experiment is performed. The experiment is automatic and unattended.

Star
Tracker

The field of view of the proportional counters is 20 degrees. To locate the x-ray sources within this large area of the sky, the experiment is equipped with two star trackers. These photoelectric sensors detect selected bright visible stars. The data from the star trackers is correlated with the boosters known location and attitude to determine the location of the x-ray source.

EXPERIMENT DATA

Flight

The galactic x-ray mapping experiment is installed in the instrument unit of the booster stage of the second manned Skylab mission.

Following separation of the booster from the command module, the batteries in the booster will provide approximately seven hours of operation for the experiment for an orbital lifetime of five revolutions. The expended booster will be positioned in a different attitude in each orbit to ensure that as large a portion of the sky may be surveyed as possible.

Tape
Recorder

During the lifetime of the experiment, a tape recorder records data which is played back at a high speed on command when the booster passes over a ground receiving station.

The recorded data include 50 channels of pulse height data (5 channels from each of 10 proportional counters), 2 star tracker data channels, and booster position and attitude data.

CREW ACTIVITY

The experiment is completely automatic and requires no crew participation.

RELATED CLASSROOM TOPICS

The galactic x-ray mapping experiment provides opportunity for a number of classroom discussion topics.

Astronomy

- classification of stars,
- types of stars that are probable x-ray sources,
- stellar x-ray intensity and spectra in relation to solar x-ray;

Physics

- energy levels of x-rays,
- soft and hard x-rays;

Electronics

pulse measurement and selection systems,
feedback systems for control devices.

Student
Experiment

SPECTROGRAPHY OF SELECTED QUASARS

EXPERIMENT BACKGROUND

Radio astronomy investigations have revealed the presence of celestial sources of radiation that are in the radio spectral region. These quasi-stellar radio sources (quasars) also visually exhibit extreme red shifts. Several quasars have been subsequently visually located by photographic methods.

It is suspected that some of the quasars may also radiate ultraviolet energy that is absorbed in Earth's atmosphere. Observation or detection of this ultraviolet energy would greatly enhance our understanding of the energy mechanism of these celestial objects that are believed to be the most distant observed objects in the universe.

SCIENTIFIC OBJECTIVES

The objectives of the spectrography of selected quasars experiment is to obtain the spectra in the ultraviolet spectral regions. This experiment is one of the series proposed by high school students in the Skylab Student Project.

EXPERIMENT HARDWARE

The spectrography of the selected quasars experiment will use the same spectrographic telescope and camera as the ultraviolet stellar astronomy experiment.

EXPERIMENT DATA

Photographs obtained from the ultraviolet stellar astronomy star fields that include the celestial coordinates of known quasars will also be examined for ultraviolet radiation from those quasars.

Student
Experiment

A SEARCH FOR PULSARS IN THE ULTRAVIOLET WAVELENGTHS

EXPERIMENT BACKGROUND

Pulsars

Pulsars are stars that emit extremely regular pulses of radio energy at intervals of about one second. Theory indicates that these are extremely dense, rapidly spinning neutron stars—dying stars that have collapsed to such a degree that the atomic nuclei have been crushed and only neutrons remain. In only one case, the Crab nebula, is the neutron star

visible in the ordinary wavelengths of light which penetrate the Earth's atmosphere. Since these stars are extremely hot, it is possible that the stars are better visible in ultraviolet wavelengths which do not penetrate the Earth's atmosphere.

By using the ultraviolet stellar astronomy experiment pointed at the region of sky covering the celestial coordinates of known pulsars, it may be possible to record their ultraviolet radiation.

SCIENTIFIC OBJECTIVES

The objective of the ultraviolet study of pulsars is to derive more information on these objects and to relate the ultraviolet emissions of pulsars to their spectral characteristics in other ranges. This is another of the Skylab Student Project Experiments.

EXPERIMENT HARDWARE

A search for pulsars in the ultraviolet wavelengths uses the telescope and camera of the ultraviolet stellar astronomy experiment.

EXPERIMENT DATA

The search for pulsars in the ultraviolet wavelengths uses the photographs produced in the ultraviolet stellar fields which include pulsars in the field of view.

RELATED CLASSROOM TOPICS

Classroom topics in astronomy such as:

- eclipsing binaries,
- intrinsic variable stars,
- Cepheids,
- periods of variable stars, and
- stellar magnitude,

are subjects relating to this experiment.

X-RAY CONTENT IN ASSOCIATION WITH STELLAR SPECTRAL CLASSES

EXPERIMENT BACKGROUND

In addition to visible and ultraviolet radiation, many stellar objects are suspected to radiate x-ray wavelengths in a similar manner to the Sun. Through rocket flights, some celestial x-ray sources have been located; however, the flights have

been of short duration and the x-ray detectors of limited capability.

SCIENTIFIC OBJECTIVES

The x-ray content in association with stellar spectral classes will analyze x-ray spectrographic telescope data of the Sun (Volume 1, Sections 6 and 7). Considering the Sun as a class G star, an attempt will be made to establish a relationship between the age of the star, its spectral class, and the intensity of x-rays. If possible, the x-ray spectrographic telescope of the Apollo telescope mount will be used to record other stellar x-ray sources. This also is a Skylab Student Project Experiment.

Section 5

Spacecraft Environment

CONTAMINATION MEASUREMENT

CORONAGRAPH CONTAMINATION MEASUREMENT

RADIATION IN SPACECRAFT

CONTAMINATION MEASUREMENT

EXPERIMENT BACKGROUND

History The contamination measurement experiment is designed to evaluate the extent and effects of contamination surrounding the exterior of the Skylab spacecraft.

Beginning with the first manned flights into space during the Mercury space program in 1961, it was noted that spacecraft windows became clouded over for, then, unexplainable reasons. In 1962, John Glenn reported that he saw something that looked like "fireflies" outside of his Mercury spacecraft window. The astronauts who took part in the Gemini program found that astronomical observations were degraded by cloudy windows. Even the more recent Apollo moon flights have been hampered by contaminated spacecraft surfaces.

Physics Induced Atmosphere It has been found that all spacecraft launched into space have a residual atmosphere that surrounds and travels with the vehicle. With a large spacecraft such as Skylab, the problem becomes more severe because of the presence of human beings and the life support provisions necessary for their survival.

Contamination Sources There are a number of sources from which this contaminating atmosphere is derived. Typical of those sources that result from the spacecraft structure and active systems are:

- 1) outgassing of basic materials of the vehicle on exposure to the vacuum of space;
- 2) small leaks of fluids and gases from spacecraft gas and hydraulic systems;
- 3) engine exhaust vapors and particles from rockets used to maneuver the spacecraft;
- 4) deterioration of paints and surface coatings which results from ultraviolet radiation of the Sun.

In addition to the sources from the spacecraft, there are numerous sources resulting from the astronauts' habitation, such as:

- 1) leakage of spacecraft cabin air through hatch seals—estimated at 2.3 kg (5 lb) per day. Cabin air contains oxygen and nitrogen, plus all of the gases exhaled by the astronauts;
- 2) water extracted from the astronauts' environmental control system (air conditioning);

Human breath contains over 90 different chemical compounds

Water from environmental control system contains salts and acids

- 3) vapors and particles resulting from the waste management systems. Waste products are dumped into a tank at the aft end of Skylab. The tank is vented to space through a fine mesh filter so that volatile products eventually migrate to space as vapors. These vapors are similar to the sewer gases of ground waste systems and are vented at a rate of approximately 5.4 kg/day.

Induced Atmosphere Density

The various sources listed above combine to produce an atmosphere surrounding the Skylab cluster which is computed to have a density of 2.5×10^{-11} gm/cm³. The density of the ambient space atmosphere has been found to be 4×10^{-15} gm/cm³. Thus, the atmosphere surrounding Skylab is nearly 10,000 times as dense as the ambient space. In space, it is necessary to reference atmospheres in terms of density. Terms of pressure are irrelevant since space is boundless and is not contained.

Normal atmospheric density at sea level is 1.3×10^{-4} gm/cm³

The resultant atmosphere is composed of many gaseous compounds from basic materials and human occupancy.

Contami- nation Effects

Because of their greater density, many of the compounds in the surrounding atmosphere deposit on the various surfaces and so contaminate them. Several spacecraft systems may be adversely affected. Included in these are:

- 1) Optical Systems: windows, lenses, mirrors. Contamination of these surfaces impairs scientific observation.
- 2) Electrical Systems: contaminant deposits on solar power arrays will reduce power generation.
- 3) Thermal Control Paints: contaminant deposits on these surfaces change their solar absorptance and reflectance which affects overall temperature of the spacecraft.
- 4) Star Tracker: disorientation from light reflected by particles.

In addition, the density of the atmosphere may cause light scattering and affect ability to observe faint light sources (stars). This is especially so when the Sun is situated at an angle to the observing line-of-sight.

SCIENTIFIC OBJECTIVES

While contamination became evident during the Mercury, Gemini, and Apollo flights, these programs did not attempt to analyze or control contamination, other than a few deposition samples on exterior surfaces of Gemini XII. The Skylab program is the first space program in which a major effort has been directed toward analysis and control of contamination.

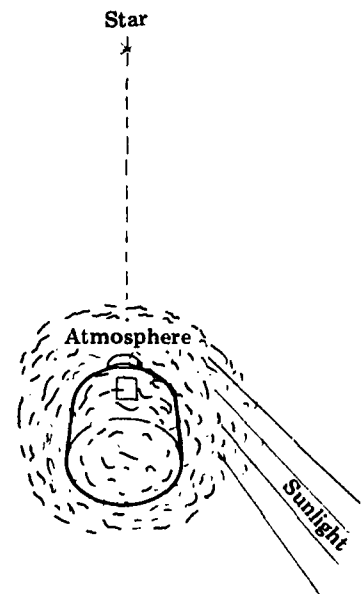

The contamination measurement experiment will assess the contamination of the Skylab induced atmosphere in several different ways.

Sample Array A large number of material samples will be deployed outside of the orbital workshop. These samples will collect deposits of contaminant vapors and gases. The samples will be returned to Earth for analysis of the deposits and possible reactions with the materials. Samples will be deployed at two different positions and directions to indicate a gradient of contaminant density.

Quartz Crystal Micro-balances Quartz crystal microbalances will determine the rate at which contaminants accumulate. When the quartz crystal microbalance is in the shadow of the spacecraft and is on the cold side, vapors and gases will condense on the sensor and cause a high rate of deposit. As the sensor shifts around into the Sun, some deposits will again evaporate away. However, some of the materials will still adhere to the surface. As a result, an average rate of contaminant deposition may be derived over several cycles.

Photometer Just as smog obscures our vision on Earth because of light scattering and absorption, the induced atmosphere about Skylab may reduce the visibility of observations. A photometer will measure the optical density and light scattering effects of the atmosphere.

It is expected that this experiment will have beneficial results in further understanding the behavior of many materials in severe ultraviolet radiation. Also, the chemical actions that result from photo polymerization may provide insight to the development of improved materials and new chemical products.

Photo Polymerization—the reaction between two or more chemicals which results from sunlight.

EXPERIMENT HARDWARE

The contamination measuring experiment is designed to be deployed to the Skylab exterior through the scientific airlocks. The experiment consists of two different major assemblies which are extended through the airlocks at different times during the mission. The two assemblies are the sample array system and the photometer system.

Sample Array System The sample array system contains 248 material samples; 21 different types of samples, basic materials, materials with special coatings, or special optical devices, are used. The 21 types of samples are:

Fused silica	Suprasil Si
Magnesium fluoride	MgF_2
Lithium fluoride	LiF

Sapphire	
Aluminum foil	Al
Germanium	Ge
Potassium	RS5 (potassium bromide optical crystal)
Beryllium foil	Be
Magnesium fluoride coated aluminum	
Lithium fluoride coated aluminum	
Platinum	Pt
Nickel	Ni
Gold	Au
Diffraction grating	
Germanium, treated for reduced reflection	
Aluminum, structural thickness	
Aluminum mirror	
Iridium mirror	
Beryllium mirror	
S136, white thermal control paint	
Black anodized aluminum	

Figure 5-1 shows the sample array deployed through the Skylab wall and meteoroid shield. The material samples are positioned on the lower carousel, the post, and the upper box and upper carousel. The lower and upper carousels are separated by 20.5 cm (8 in.). When the sample array is deployed through the scientific airlock, the lower carousel is positioned approximately 12.5 mm (0.5 in.) from the meteoroid shield. Thus, the lower carousel will accumulate contaminants close to the spacecraft. Samples on the post and box will gather accumulations dependent on the induced atmosphere gradient. Samples on the upper carousel will accumulate deposits approximately 18 cm (7 in.) out from the spacecraft surface.

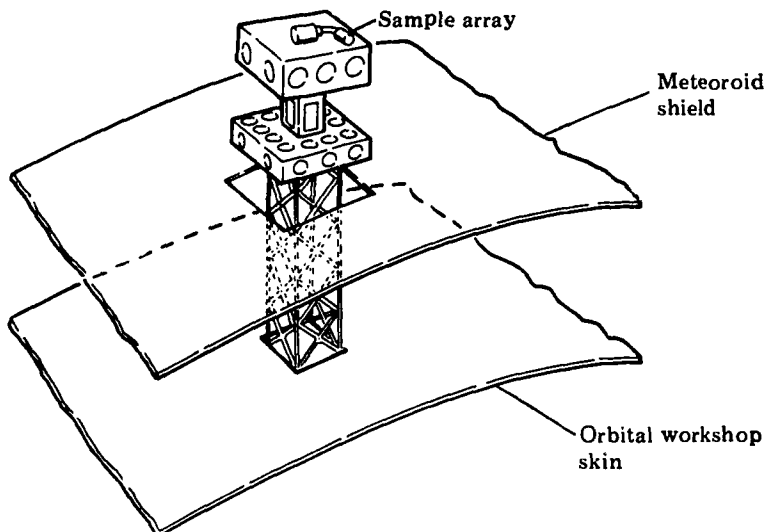

Figure 5-1 Contamination Sample Array

The sample array will be deployed for five days continuously, early in the first manned mission. At this time, outgassing of materials on exposure to vacuum is near maximum and contaminant deposits are greatest. Timer actuated covers on the lower carousel are arranged to expose some samples for one hour and some for two hours during the first day. Similar covers on the upper carousel expose five groups of five samples each for one day for each group during the five days of experiment operation. Remaining samples which are not covered are exposed for the entire five-day period. The experiment canister contains 45 samples and the experiment when it is stowed. These samples are control samples and are never exposed to space. They serve to provide a reference base in the data analysis.

**Quartz
Crystal
Micro-
balances**

Quartz crystal microbalances are located on the upper carousel and box. These are electronic devices which measure the rate of contaminant depositon and the total mass deposited on them. They are very sensitive, being able to measur a deposit of 10^{-5} microgram.

The block diagram depicts the basic concept of the quartz crystal microbalance. The frequency at which a quartz crystal will oscillate (piezo-electric effect) is a function of the mass of the crystal. In this device two oscillators are used, each one using a crystal of a precisely matched pair. Crystal 1 is located so that contaminants can deposit on its face. Crystal 2 is located behind crystal 1 but is protected from deposits. Both crystals are in thermal contact to avoid temperature differences.

When both crystals are clean, both oscillators will operate at the same frequency. Their outputs are connected to a mixer that produces a beat frequency, which is initially zero. As crystal 1 accumulates a contaminant deposit its mass becomes greater and oscillator 1 operates at a lower frequency. However, as the difference between the oscillators becomes greater, the output beat frequency from the mixer increases. The beat frequency is thus proportional to the mass deposited on crystal 1.

The beat frequency of the mixer is connected to a discriminator that provides a dc voltage proportional to frequency input. The dc voltage represents the instantaneous total mass deposited on crystal 1. The output of the quartz crystal microbalance is in volts/microgram.

The output of the discriminator is now differentiated by the dc-dc differentiator. This differentiated output is a voltage that represents the rate of change of the beat frequency or the change in mass in crystal 1. The unit of measurement of the differentiator is micrograms/sec/volt.

Microgran. - 1 millionth gram

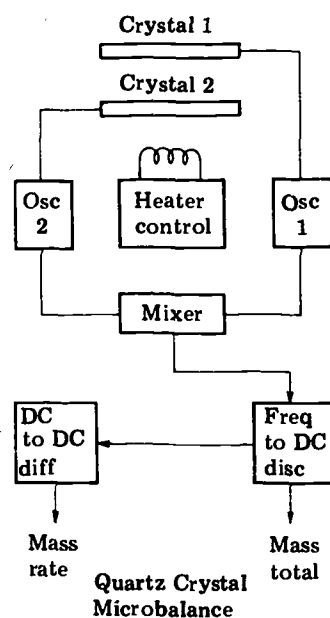

Beat Frequency—A frequency which is the sum or difference between two other frequencies.

Photometer

The photometer is used to assess the light scattering of the Skylab induced atmosphere. It is also used to study gegenschein and zodiacal light for astronomical purposes. (See Section 4.)

The photometer is extended on a boom through a scientific airlock, so that it may view in various directions about the vehicle. The photometer is pivoted in two axes so that it may view a sky area slightly more than a hemisphere.

The prime component of the photometer is a photomultiplier tube that produces an electron current proportional to light flux on its faceplate. Photomultipliers are very sensitive and can detect light intensities as small as 10^{-8} foot candles. (A dark moonless night provides illumination of 10^{-5} foot candles.)

The photomultiplier tube is complemented by 10 color filters, a polarizing filter, and an aperture wheel to control the field of view. Five color filters are installed in each of two filter wheels. Each filter wheel has an open position to permit color filters of the other wheel to be used. Filter wheel A is in the open position when filter wheel B filters are used, and vice versa. (See Figure 5-2.) The color filters are:

Position 1	Wheel A (Angstroms)	Wheel B (Angstroms)
1	Blank	Blank
2	4000	6080
3	4760	6300
4	5080	6435
5	5300	7100
6	5577	8200

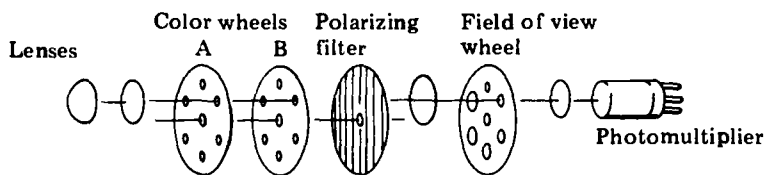
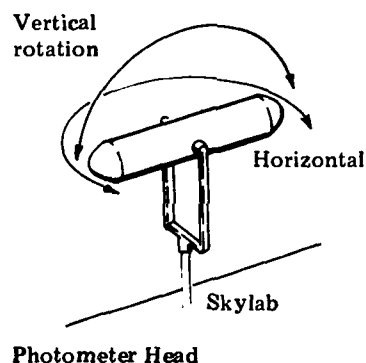

Figure 5-2 Optical Scheme of Photometer

A polarizing filter wheel is located between the color filters and the photomultiplier. The polarization filter passes light that is oriented in the plane of polarization of the filter and rejects light that is not in that plane. Since light from gegenschein and zodiacal light is polarized while scattered light from the atmosphere is not, the polarizing filter will permit separation of these sources of light.

A 6-position aperture wheel is used to select the field of view of the photometer for various observations. It also includes neutral density filters to reduce very bright light fluxes. The fields of view (FOV) and neutral density filters are:



Photometer Head

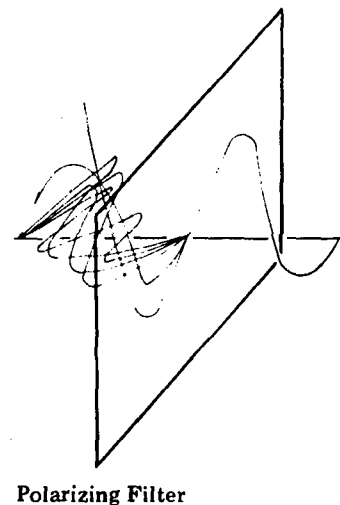

Polarizing Filter

Position	FOV, deg	Neutral Density Filter	Neutral density filters reduce or attenuate light equally throughout the spectrum. Ratings are:	
1	6	—	FILTER	ATTENUATION, %
2	3	—	0	0
3	3	2	1	90
4	1	—	2	99
5	1	3	3	99.9
6	1	4	4	99.99
			5	99.999

An automatic programmer provides the controls to select color filter selection, field of view, and viewing direction of the photometer. Since the photometer is used for astronomical observations as well as contamination evaluation, there are as many as 20 different programs which the programmer can provide. Different programs are required for the type of observation and for the sunlit or dark portions of an orbit.

A 16mm camera supplements the photometer. Its field of view is slightly larger than that of the photometer, so it photographically records an image of the light sources for the photometer.

EXPERIMENT DATA ANALYSIS

The sample array carousels will be returned to Earth at the conclusion of the first mission. Chemical and optical analysis will be performed on the deposits on each sample. The chemical analysis will analyze the chemistry of every deposit so that its source from the Skylab spacecraft can be determined. Unknown products that result from photo polymerization will be of particular interest. Optical analysis will be concerned with the transparency or absorption of each deposit and the spectral effects on optical surfaces.

The data from the quartz crystal microbalances are transmitted to ground during the mission. They are correlated with flight activities and vent and dump operations to develop a relationship between these events, and the rates and times when deposits form on the sample arrays.

The photometer data are also transmitted to ground during the mission. Preliminary analysis will be performed to assess the optical characteristics of the induced atmosphere. However, some of the photometer data analysis must wait until the film from the camera is returned to permit correlation.

RELATED CLASSROOM TOPICS

Chemistry

vapor pressure of solids

Photography

characteristics of filters, polarized light, photometers,

Physics

photomultipliers.

CORONAGRAPH CONTAMINATION MEASUREMENT

EXPERIMENT BACKGROUND

The induced atmosphere surrounding Skylab has been calculated to be 10,000 times denser than the surrounding ambient atmosphere of space. Because of this difference, there will be an increase of light scattering from the gas molecules of the induced atmosphere over the scattering in space.

The induced atmosphere may thus be analyzed with a coronagraph, which eliminates the intense light from the Sun and receives only the scattered light of the atmosphere.

Physics

When one body passes in front of another, the first is said to be occulted. During an eclipse, the Moon occults the Sun. A coronagraph employs a series of discs to occult the Sun to produce an artificial eclipse. In Volume 1, Section 3 of this series, the application of a coronagraph to eclipse the Sun in order to study the solar corona was explained.

The contamination coronagraph employs the same concept to occult the Sun. However, in order to study the induced atmosphere, the occulting discs are designed to subtend an angle of 4 degrees at the point of observation, in contrast to the approximate 0.5 degree in the solar coronagraph. The occulting discs thus not only occult the solar disc but also eclipse the solar corona. Consequently, the light that is seen at the point of observation will be the result of light scattering in the atmosphere.

SCIENTIFIC OBJECTIVES

The contamination coronagraph is used to record scattered light from the induced atmosphere about the spacecraft during various mission activities.

Photography of scattered light in the spacecraft induced atmosphere during these atmospheric states will provide insight to contamination control on future spacecraft.

A secondary objective of the contamination coronagraph is to photograph, if possible, the solar F corona. Aside from the visible solar corona (Volume 1, Section 3) there is a suspected tenuous corona composed of particles and dust of solar material. (See Section 2.) An average background brightness measurement made by photography during the quiescent atmosphere state will indicate the presence of the solar F corona.

Atmospheric States:

- 1) quiescent atmosphere when no spacecraft venting or dumping is taking place;
- 2) dumping liquids into the waste tank;
- 3) venting to space from materials processing experiments.

EXPERIMENT HARDWARE

The contamination coronagraph is installed in the solar scientific airlock to observe the Sun.

The experiment consists of a boom with the occulting disc assembly and a camera system. Three occulting discs are used to eliminate diffraction effects of a single disc. (See Volume 1, Section 3.)

The camera is a special Nikon 35mm camera. It is provided with two 55mm interchangeable lenses. One lens is ground from fused quartz to allow photography in near visible ultraviolet.

An accessory filter assembly contains polarizing, color, and ultraviolet filters.

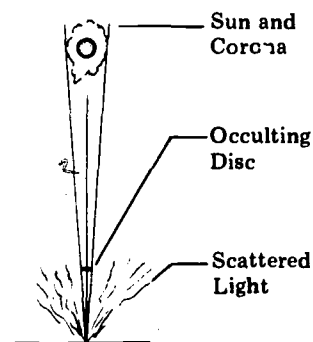

EXPERIMENT DATA

The contamination coronagraph experiment will provide extensive data on the characteristics of spacecraft induced atmospheres. Particles as small as 10- or 20-micron diameter will be visible in the photographs. Thus, changes of the induced atmosphere with respect to spacecraft activities are readily apparent. This data will also be correlated with the contamination measurement experiment.

CREW ACTIVITIES

At designated times, an astronaut will install the contamination coronagraph in the solar scientific airlock and perform the required photographic sequence. Simultaneously, he will make voice comments and written log book entries describing experiment activities.

RELATED CLASSROOM TOPICS

A classroom topic in physics that is related to this experiment is the Rayleigh and Mie scattering theories.

RELATED CLASSROOM DEMONSTRATION

This experiment may be simulated as a classroom experiment. A coronagraph can be constructed similar to the one illustrated in Figure 5-3.

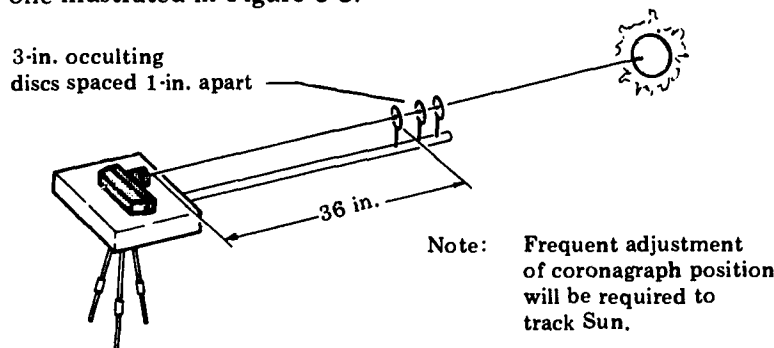

Figure 5-3 Coronagraph Demonstration

The demonstration is set so that the distance from the camera lens to the first occulting disc is 91.44 cm (36 in.). At this distance, the discs will subtend an angle of approximately 5 degrees. The complete experiment is mounted on a tripod for ease of mounting.

- 1) Set up the experiment so that the camera lens is centered in the shadow of the occulting discs.
- 2) Photograph the scattering of the clear atmosphere.
- 3) Use a garden hose and spray a fine mist of water in the field of view of the coronagraph and photograph resultant scattering.
- 4) Take photographs using 1, 2, or 3 occulting discs to determine effects of diffraction on data.

RADIATION IN SPACECRAFT

EXPERIMENT BACKGROUND

Primary Cosmic Radiation

In orbit, the Skylab spacecraft is penetrated by primary cosmic rays which are nuclei of various atoms. The primary particles also cause a secondary radiation when they impinge on the spacecraft structure. The astronauts within the confines of the spacecraft are thus exposed to these two types of radiation. For health reasons, it is important to monitor the radiation levels at several locations so that the effectiveness of varying amounts of shielding in the spacecraft can be evaluated with respect to the radiation dosage the astronauts receive.

Secondary - Charged Particles—protons, neutrons, gamma rays and electrons

Energetic Particle Concentrations

Concentrations of secondary charged particles arise from three causes. A major concentration occurs in the South Atlantic anomaly of the Van Allen radiation belt where it is closest to Earth's surface. A second concentration of charged particles is in the auroral zones at high latitudes. In these zones, the particles are accelerated along and follow the geomagnetic lines of force of the Earth. The third source of concentrations of charged particles is associated with the occurrence of solar flares.

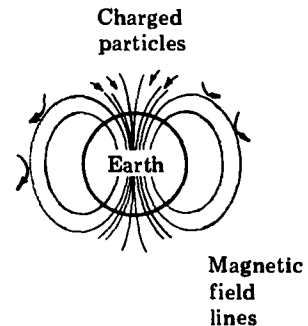

Secondary Radiation

The secondary radiation, type and intensity, is dependent on the type and thickness of the spacecraft material on which primary cosmic radiation and high energy protons interact. The geometry of the structure and location within the spacecraft also are factors influencing the secondary radiation.

Effect of Earth's Magnetic Field on Cosmic Ray Particles

Astronaut Absorption

The radiation energy absorbed by the astronaut depends on the type of tissue (muscle, bone, fat), the kind and energy of the radiation, and the amount of shielding afforded by

surrounding structure and parts of the astronaut's body. During the Apollo lunar flights, several astronauts reported sensations of light flashes with their eyes closed. This effect is thought to be caused by cosmic rays affecting the optic nervous system.

SCIENTIFIC OBJECTIVES

The radiation in spacecraft experiment has several scientific objectives. The evaluation of advanced techniques of active and passive radiation measurement for use on future manned spaceflights and in industry will be carried out. The experiment data will also be correlated with theoretical computer analyses to predict radiation hazards to crewmen in differing orbits and space environments. Data from the radiation measurements will be correlated with the radiation-induced biological effects observed in the astronauts.

EXPERIMENT HARDWARE

The radiation in spacecraft experiment is comprised of one active and five passive dosimeters. The active dosimeter is an electronic system that yields data on ambient radiation levels in its proximity. The passive dosimeters operate through analysis of the cumulative effects of radiation on several materials.

Dosimeter—a device that measures radiation dosage.

Active Dosimeter

The active dosimeter consists of two major subsystems. One subsystem measures radiation levels using an ionization chamber which is designed to simulate effects in body tissue (tissue equivalent ionization chamber). The other subsystem uses solid-state diodes exposed to radiation and a pulse height analyzer to yield a spectrum of proton and alpha particle energies. This subsystem is called a linear energy transfer spectrometer.

Tissue Equivalent Ionization Chamber

The tissue equivalent ionization chamber is a gas-filled diode tube in which the gas in the chamber is ionized by penetrating radiation, resulting in electron currents at the tube electrodes. This same principle is used in proportional counter tubes for x-ray analysis. (Section 8 of Volume 1, and Section 4 of this volume.) The tissue equivalent ionization chamber outer wall is fabricated of special plastic resins that simulate the radiation absorption characteristics of human muscle tissue.

Figure 5-4 is a cross section drawing of the tissue equivalent ionization chamber. The chamber includes an electrometer amplifier to isolate the inner electrode (anode) from electrical interference. The electrometer amplifier amplifies the electrode current to a level suitable for the telemetry system and transmission to ground. The tissue equivalent

Telemetry—a system for transmitting data, often by radio

ionization is equipped with a 2-meter (6.5 foot) extension cord to permit it to be used for radiation measurements in various areas of the spacecraft and around an astronaut's body.

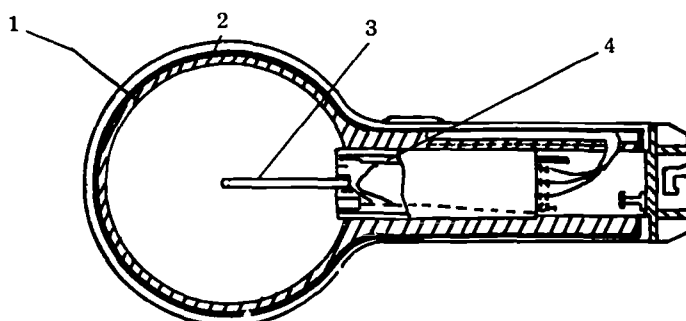

1. Outer electrode
2. Epoxy
3. Inner electrode
4. Electrometer-Amplifier

Figure 5-4 Tissue Equivalent Ionization Chamber

Linear
Energy
Transfer
Spectrometer

The linear energy transfer spectrometer is comprised of two lithium solid-state diodes that detect cosmic particle penetration. When a proton, alpha particle, or cosmic ray penetrates the body of the diode, the electrical resistance is momentarily changed, causing a current pulse through the diode. Both diodes are shielded with tungsten so that radiation can enter only from one side of the diode. One diode is made 2 mm thick; the other is 1 mm thick. They will thus have differing sensitivities to particle energies.

The diodes are operated in an anti-coincidence circuit. When the same pulse is detected in both diodes, no output results; only when a pulse is registered in one diode or the other will an output result. Pulses from one diode thus form one portion of the spectrum, and pulses from the other diode form the other part.

Pulse Height
Analyzers

The pulses generated in the linear energy transfer diodes are analyzed in a 6-channel pulse height analyzer. This circuit accepts a series of pulses at its input and sorts them according to their amplitude into six different ranges. Since the pulses generated in the diodes are determined by the radiation energy in the diodes, the output of the six channels of the pulse height analyzer represents a spectrum of radiation energy. When pulses at the output of each of the six channels are counted, the count represents the intensity of the energy in each spectral range, respectively. Pulse height analyzers are also used for x-ray analysis and are discussed in Section 8 of Volume 1 and Section 4 of this volume.

Spectrum

The resulting radiation spectrum from the pulse height analyzer ranges from 0.5 MeV for low energy protons to 75

MeV for high energy alpha radiation. The complete spectrum is tabulated.

Diode	Particle	Energy, MeV
1	proton	0.5 - 2.0
1	proton	2.0 - 6.0
1	proton	6.0 - 10.0
1	proton	10.0 - 14.0
1	proton	14.0 - 18.5
1	alpha	18.5 - 75.0
2	proton	-- 18.5
2	alpha	-- 75.0

The linear energy transfer spectra resulting from the particle energy measurements indicate the relative biological effectiveness of the radiation. The relative biological effectiveness is the expression of the effectiveness of other radiation (protons, alpha) compared to 1 roentgen of gamma rays. This relationship is used to determine the radiation induced biological effects on man. (See Volume 4, Section 3.)

Figure 5-5 shows the configuration of the active dosimeter.

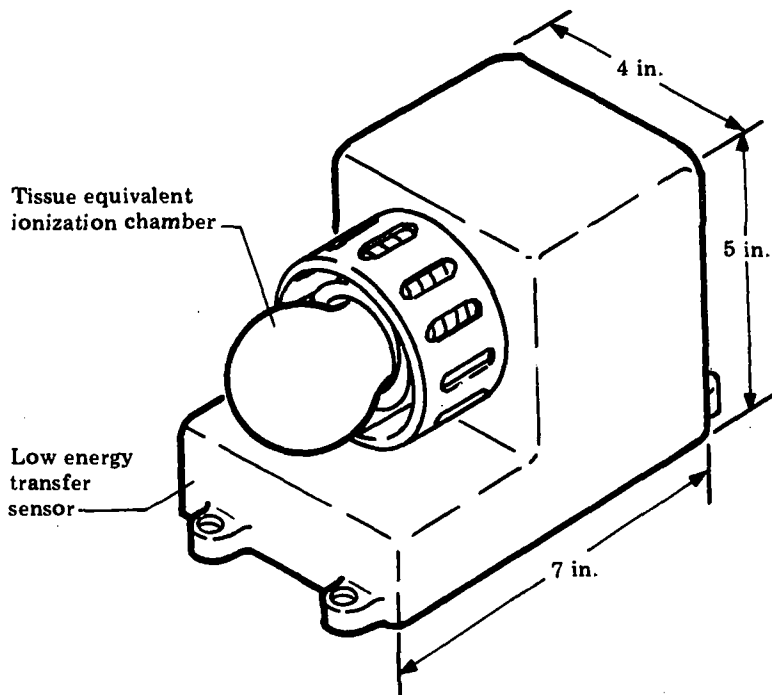

Figure 5-5 Active Dosimeter

Roentgen—basic unit of radiation intensity 1 roentgen—produces ions to cause a charge of 1 electrostatic unit in 1cc^3 of dry air.

Rad—the amount of radiation to cause 100 ergs of energy to be absorbed in 1 gram of an irradiated material

In body tissue 1 roentgen is approximately equal to 1 rad.

Radiation of 25 to 100 rad/day may cause an increase of blood pressure.

100 to 200 rad/day may cause fatigue, nausea and vomiting.

A whole body dose of 600 rad may be fatal.

**Passive
Dosimeter**

Five passive dosimeters, located at strategic locations in the command module, determine the accumulated radiation effects throughout the flight. When the cumulative dosage of each dosimeter is analyzed, the data permit a plot of radiation distribution in the command module to be developed.

The passive dosimeters are each comprised of five different elements employing different techniques to detect radiation. The different elements combined yield a total range for the passive dosimeter of 5 millirads to 5000 rads. The five elements of the passive dosimeter are (1) lithium fluoride and calcium fluoride thermoluminescent crystals, (2) nuclear emulsions, (3) plastic polymers, (4) quartz fiber ionization chamber, and (5) gold and iridium foils.

**Thermo-
luminescent
Crystals**

When crystals of lithium fluoride and calcium fluoride are irradiated, electrons are trapped at imperfections at the crystalline boundaries in the crystal lattice. At temperatures of 22°C (70°F) trapping is quite stable, and, with greater radiation, more electrons are trapped.

After irradiation, the crystals are heated. The heat agitates the trapped electrons and allows them to combine with ions in the crystal structure. In the process of combination, visible light is emitted and the intensity of light is a function of the irradiation energy stored in the crystal. The configuration of the thermoluminescent detector is a small vacuum tube. The thermoluminescent crystals are deposited on a wire filament heater. During flight, radiation energy is stored in the crystals. After flight, power is applied to the heater and the light produced by the crystals is measured.



Thermoluminescent Tube

**Nuclear
Emulsions**

When halide emulsions (similar to photographic film) are penetrated by cosmic ray particles, the particles dissipate their energy by ionizing the halide emulsion. When the emulsion is developed chemically, the emulsion shows the locale of the penetration and the size of the developed spot indicates the mass of the cosmic particle. Different formulations of the nuclear emulsion yield differing sensitivities. (See Section 3.)

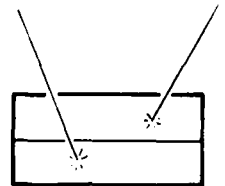

Halide Film

In the passive dosimeter, the nuclear emulsion sensor is made from two emulsions. In this way, low energy particles are trapped in the first low sensitivity layer, and higher energy particles pass through the first layer and are trapped in the second.

**Plastic
Polymers**

Plastic polymers behave in a manner similar to the nuclear emulsion. As a cosmic particle penetrates the plastic, its energy causes fusing of the plastic, leaving a well-defined path. Chemical etching reveals the track for analysis. This process is described in Section 3.

Different plastic polymers have different sensitivities to cosmic rays and will reveal particles of differing energies. The passive dosimeter uses three polymers in a stack to yield data of three different energy levels.

**Quartz Fiber
Ionization
Chamber**

The application of ionization chambers to detect radiation was previously discussed in the active dosimeter, equivalent tissue ionization chamber. Similar applications are discussed in Volume 2, Section 8.

In the passive dosimeter, the ionization chamber is of a somewhat different form. The chamber walls are of fused quartz and the central element is a crystal grown quartz fiber. Both of these are very good insulators as opposed to the conductive electrodes in other applications.

Ionization of the chamber gas in this case causes an electric charge to accumulate on the elements. As long as irradiation persists, an electric charge on the insulating surface accumulates. This condition occurs during flight. The process is similar to that which occurs in a gold leaf electroscope.

On return to Earth, the ionization chamber is connected to a sensitive electrometer to measure the total accumulated charge.

**Gold and
Iridium
Foil**

The passive dosimeter employs disks of gold and iridium foil to absorb energy from alpha particles and low energy protons. This process is also used and described in the magnetospheric particle experiment (Section 3). The different materials have different threshold sensitivities to low energy particles, thereby providing selectivity of detection.

Figure 5-6 is an exploded view of the passive dosimeter.

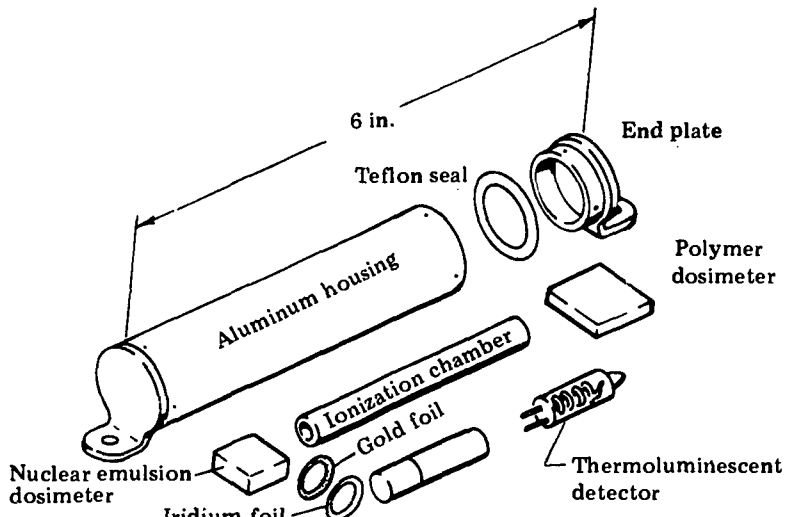

Figure 5-6 Exploded View of Passive Dosimeter

EXPERIMENT DATA

The active dosimeter data are transmitted to ground where they will be analyzed promptly. In particular, increased radiation levels in the South Atlantic anomaly and during periods of solar activity are of immediate concern. Radiation levels measured in relation to crew activities will receive special attention.

Passive dosimeter data will be analyzed postflight. Because of the variation of the five types of detectors in this dosimeter, a complete spectrum of primary and secondary radiation, with respect to particle energy in the spacecraft, will be determined.

CREW ACTIVITIES

The tissue equivalent ionization chamber of the active dosimeter is used by a crewman to determine radiation levels within reach of this cable.

In addition to surveying radiation in the command module, during flight in the South Atlantic anomaly, the northern auroral zone and during solar flares, crewman body surveys will also be performed.

The body survey is conducted by a crewman holding the tissue equivalent ionization chamber on various locations of the body. These locations include his chest, stomach, armpits, and groin.

RELATED CLASSROOM TOPICS

Radiation characteristics are related to many classroom topics:

Chemistry

- ions, protons, neutrons,
- nuclear reactions;

Physics

- nuclear physics,
- high energy particles,
- high energy shielding and absorption.

CLASSROOM ACTIVITIES

Investigation of Radiation on Organisms—An interesting demonstration on the effect of ultraviolet radiation on microorganisms is described in *Biological Science—Molecules*

to Man, p 761. This material could be used as a stimulus for discussions on the effects of radiation. Other radiation effects can be discussed and demonstrated in the fields of plants and insects by obtaining specimens of irradiated seeds and comparing the growth with "normal" seeds of the same types, or by obtaining information on pest control by use of irradiated insects.

Section 6

Glossary

GLOSSARY

Å	Angstrom—a unit of measurement commonly used to describe wavelengths. The unit is equal to 10^{-8} centimeters.
Airglow	A faint general luminosity in the sky, most apparent at night.
Armalon	A Teflon-coated fiberglass cloth.
Astronomical Unit (AU)	The distance from Earth to the Sun— 1.49×10^8 kilometers (93×10^6 miles).
Beat Frequency	A frequency which is the sum or difference between two other frequencies.
Black Holes	Sources of x-ray radiation in areas of the sky in which no visible stars are seen.
Celestial Coordinates	Coordinates that define the position of a star in the sky. Right Ascension locates a star in the east-west direction. Declination locates a star's position north or south of the celestial equator.
Celestial Sphere	Concept proposed by ancient astronomers consisting of a hypothetical sphere of extremely large radius centered on Earth with the fixed stars lying on the outer boundaries.
Column Density	Density or mass of a column of given cross section and length. A column of water of 1 cm^2 section and 10 cm length has a column density of 10 gm/cm^2 .
Cosmic Rays	Atoms which have been subjected to such thermal stresses as to remove the electrons leaving only the nucleus.
Dosimeter	A device which measures radiation dosage.
Earth Albedo Neutrons	Neutrons produced by cosmic rays' interaction with the Earth's atmosphere are reflected away from Earth.
Ecliptic Plane	The plane of the orbit of the Earth in its annual motion around the Sun.
Electron Volt	Energy equivalent to that of an electron accelerated by an electric field of 1 volt.
EVA	Extra vehicular activity, i.e., activity carried on outside a space vehicle by a space-suited crewman.
Fabry Image	The image of the entrance slit in a spectrograph formed by an array of cylindrical lenses.
F-Corona	A portion of the solar corona, with a spectrum resembling that of the photosphere, caused by scattering of sunlight from the photosphere by fine particles of interplanetary dust.

Flux	The rate of flow of energy, fluids, etc, through a surface.
Galactic Cosmic Rays	Positively charged particles originating from outside the solar system.
Gegenschein	A faint glow seen at the antisolar point after sunset.
Kinetic Energy	The energy possessed by an object in motion.
Libration Points	Zones of neutral gravity in a two-body gravitational system where the gravitational fields of each body nullify the other.
Magnetosphere	Regions of space about the Earth in which the Earth's magnetic field is effective in controlling charged particle motions.
Mass Spectrometer	An instrument which analyzes a gas or vapor according to the atomic mass of its components.
Mev	Million electron volt
Micrometeoroids	Particles of meteoritic dust in space ranging in size from 1 to 200 or more microns in size.
Micron	10^{-6} meter, 0.000039 inch.
Neutron Stars	Stars in which stresses are so great as to have compacted atoms so that electrons and protons have been neutralized to a single entity.
Noctilucent	Luminous during the night.
Nova	A star that exhibits a sudden and exceptional brightness, usually of a temporary nature, and then returns to its former luminosity. Supernovae have a much greater brightness than most normal novae.
Occult, Occulting	The disappearance of one heavenly body behind another.
Ozone	The molecule, O_3 , of oxygen. Produced by the reaction of ultraviolet radiation on O_2 .
Photo Densitometer	An instrument to measure the transparency of photographs.
Photometry	System of light measurement using photographic and/or photoelectric principles.
Photon	A quantum of light energy.
Photo Polymerization	The reaction between two or more chemicals which results from sunlight.
Polarization	A distinct orientation of the wave motion and travel of electromagnetic radiation.
Pulsars	Stars that visibly pulsate in their radiation. Rate of pulsing is very short (1 second and less). Pulsars are primarily radio emitters but may also radiate in ultraviolet.

Quartz Crystal	An electronic device that measures the rate of contaminant deposition and the total mass deposited on them.
Quasars	Quasi-stellar objects—stars that are powerful radio sources. Many are not visible and have been detected with radio telescopes. Visible quasars exhibit extreme red shifts in their spectra.
Rad	The amount of radiation to cause 100 erg of energy to be absorbed in 1 gram of an irradiated material.
Red Shift	The apparent increase in the wavelength of light (or Doppler effect) caused by receding motion of the source.
Roentgen	Basic unit of radiation intensity; one roentgen produces ions to cause a charge of 1 electrostatic unit in 1 cm ³ of dry air.
Scientific Airlock	An aperture in the Skylab spacecraft wall that permits experiment equipment to be extended outside the spacecraft while maintaining internal atmospheric integrity.
Secondary Radiation	Radiation caused by cosmic rays impacting any material and removing electrons (beta rays) and nuclei from it.
Solar Cosmic Rays	Cosmic rays produced by solar flares; much lower energy levels than galactic cosmic rays.
Solar Wind	The steady stream of charged particles (protons) emitted by the Sun.
South Atlantic Anomaly	An area over the South Atlantic in which the Van Allen belts lie closest to Earth surface. High particle fluxes characterize the Van Allen belts.
Spectrography	The method of analyzing stellar objects or other light source by means of their radiated spectrum.
Stellar Magnitudes	A system of measuring relative stellar brightness. Zero magnitude is the brightest star, and the naked eye visual limits extend to magnitude 6. The difference between successive magnitudes (3rd and 4th) is 2.5. The difference over 5 magnitudes (1st to 6th) is approximately 100. The planets, Mercury, Venus, Mars, and Jupiter, the Moon and the Sun are all brighter than magnitude zero and are thus assigned negative magnitudes. The Sun is -27 magnitude.
Stellar Types	A classification of stars by color, temperature, and spectrum. The types in a descending order of temperature are O, B, A, F, G, K, M, R, S, N. The Sun is a class G star.
Supernovae Remnants	Tenuous filaments of stellar material remaining from the explosion of a supernovae (i.e., crab nebula).
Telemetry	A system for transmitting data, usually by radio.
Terminator	The division between daylight and night.

Transuranic	Those nuclei whose Z numbers fall in the region of Z-92 (uranium) and beyond.
Van Allen Belt	Concentrations of protons and electrons that have been trapped in the magnetosphere.
Velcro	A two-part nylon fastening fabric: one part is a nap of small nylon hooks; the other part is a soft loop pile.
White Dwarfs	Very bright white or blue stars.
Z-Number	Classification of atomic nuclei according to the atomic number of the nucleus.
Zodiac	The band of sky extending about 8 degrees on each side of the ecliptic which contains the 10 zodiacal constellations.
Zodiacal Light	Faint light often seen after twilight or before sunrise extending from the solar point along the ecliptic plane or zodiac.

★ U. S. GOVERNMENT PRINTING OFFICE : 1973 728-968/955